

BME 361 Biomeasurement Laboratory

Biomedical Engineering Program
University of Rhode Island

Copyright © 2016

Processor

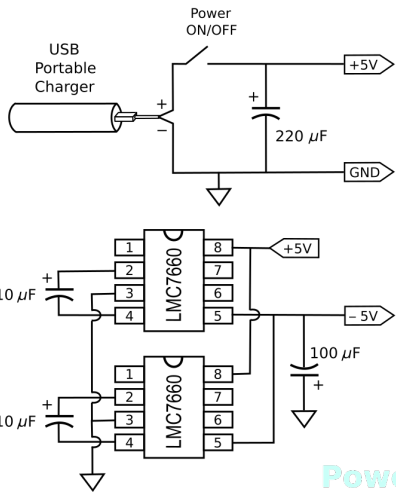
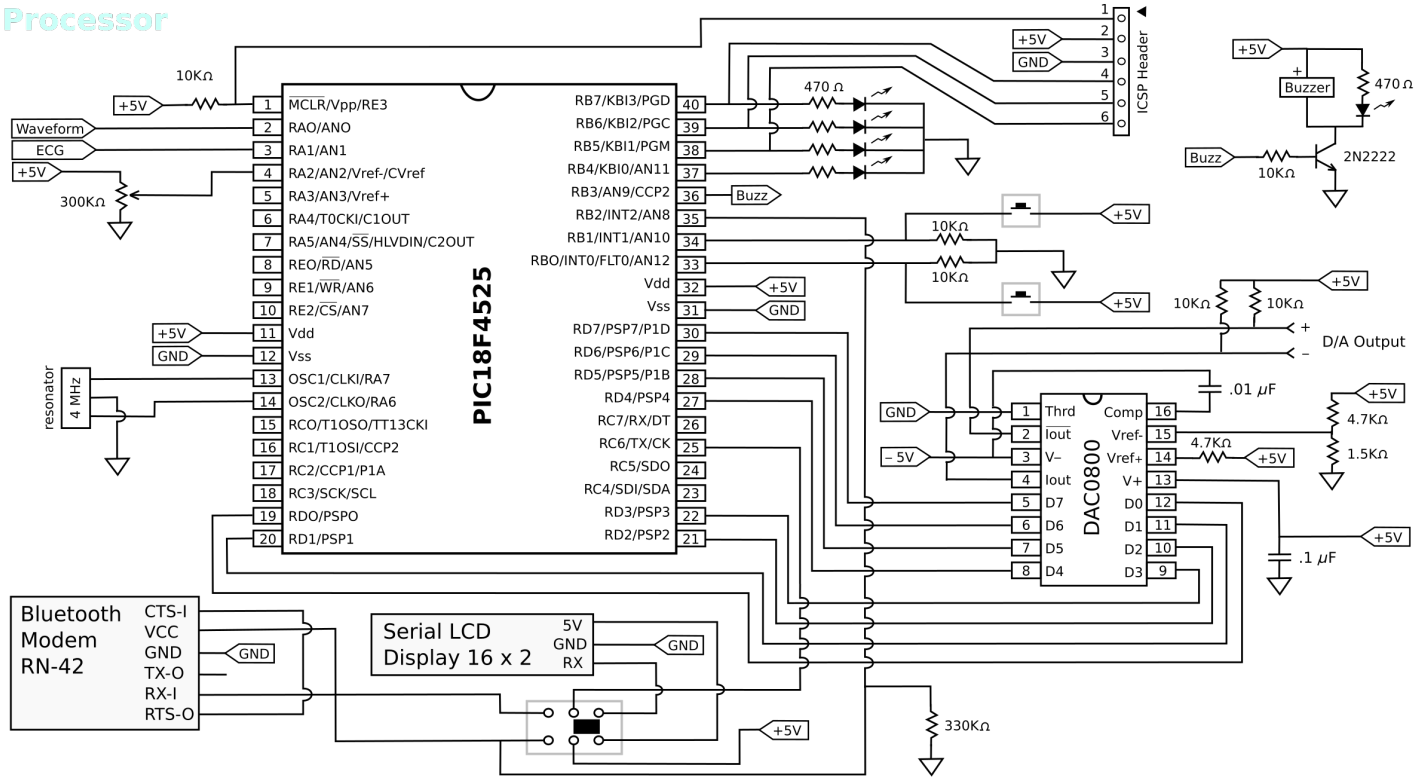

Power

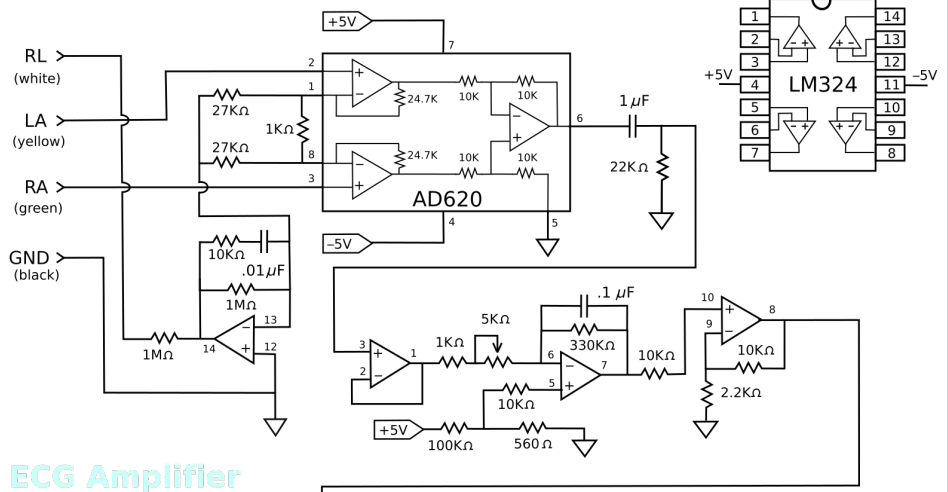

ECG Amplifier

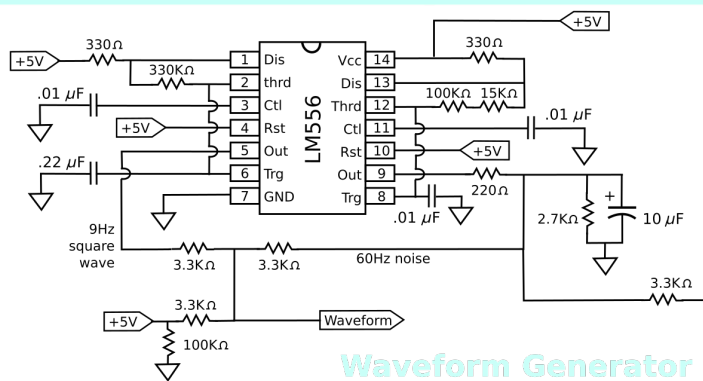

Waveform Generator

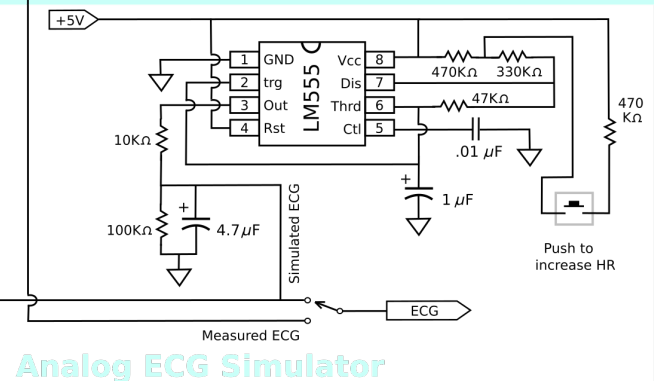

Analog ECG Simulator