

**DOT MATRIX CHARACTER  
LCD MODULE  
USER'S MANUAL**

**OPTREX CORPORATION**

**Apollo Display Technologies Inc.  
194-22 Morris Ave. Holtsville NY 11742  
Phone: (516) 654-1143 Fax: (516) 654-1496  
*www.apolloblows.com***

<u>Revision #</u>	<u>Description</u>	<u>Date Revised</u>
-------------------	--------------------	---------------------

## **Preface**

This user's manual has been prepared for all users of the OPTREX DMC series Liquid Crystal Display (LCD) modules to assist in incorporating these character type LCD modules into various applications properly and efficiently.

# Table of Contents

<b>1 FUNCTION AND STRUCTURE.....</b>	<b>6</b>
1.1 GENERAL.....	6
1.2 CHARACTERISTICS.....	6
1.3 HANDLING PRECAUTIONS .....	7
1.4 LIST OF DMC SERIES .....	8
1.5 PIN ASSIGNMENTS.....	11
1.6 BLOCK DIAGRAM .....	12
1.7 EXPLANATION OF INTERNAL OPERATION .....	13
1.7.1 Register.....	13
1.7.2 Busy Flag (BF).....	13
1.7.3 Address Counter (AC).....	14
1.7.4 Display Data RAM (DD RAM).....	14
1.7.5 Address Counter (AC).....	14
1.7.6 DD RAM Addressing.....	15
1.7.7 Character Generator ROM (CG ROM).....	21
1.7.8 Character Generator RAM (CG RAM).....	21
<b>2 MPU INTERFACING.....</b>	<b>26</b>
2.1 GENERAL.....	26
2.2 INITIALIZATION.....	26
2.2.1 Initialization using the Internal Reset Circuit .....	26
2.2.2 Software Initialization .....	27
<b>3 INSTRUCTIONS.....</b>	<b>30</b>
3.1 DETAILED EXPLANATIONS .....	30
3.1.1 Clear Display.....	30
3.1.2 Return Home .....	30
3.1.3 Entry mode set.....	30
3.1.4 Display ON/OFF Control .....	31
3.1.5 Cursor or Display Shift.....	32
3.1.6 Function Set .....	32
3.1.7 Set CG RAM Address.....	33
3.1.8 Set DD RAM Address .....	33
3.1.9 Read Busy Flag and Address .....	33
3.1.10 Write Data to CG or DD RAM.....	34
3.1.11 Read Data from CG or DD RAM.....	34
3.2 EXAMPLES OF INSTRUCTIONS .....	36
3.2.1 16 Character x 1 Line Display (1/8 duty) Using CG RAM.....	36
3.2.2 16 Character x 2 Line Display (1/16 duty).....	39
3.2.3 16 Character x 2 Line Display (4-bit interface, 1/16 duty).....	41
<b>4 ELECTRICAL CHARACTERISTICS .....</b>	<b>42</b>
4.1 ABSOLUTE MAXIMUM RATINGS .....	42
4.2 TIMING CHARACTERISTICS.....	42
4.2.1 Write Operation.....	42
4.2.2 Read Operation .....	43
4.2.3 Timing Characteristics of Each Drawing.....	44
<b>5 CONNECTION BLOCK DIAGRAMS TO MPU .....</b>	<b>45</b>
5.1 CONNECTION WITH Z-80.....	45

5.2 CONNECTION WITH 8085A.....	46
5.3 CONNECTION WITH MC 6800 .....	47
5.4 CONNECTION WITH MC 6809 .....	48
5.5 CONNECTION WITH 80C31 FAMILY (OR SIMILAR MICROCONTROLLER) USING I/O PORT INTERFACE .....	48
<b>6 SPECIAL SPECIFICATIONS.....</b>	<b>49</b>
6.1 EL (BACK LIGHT) SPECIFICATIONS FOR DMC SERIES .....	49
6.1.1 <i>Absolute Maximum Ratings</i> .....	49
6.1.2 <i>Electrical and Life Characteristics (Color emission: Blue-green)</i> .....	49
6.2 LED (BACKLIGHT) SPECIFICATIONS FOR DMC SERIES .....	50
6.3 HIGH RELIABILITY SPECIFICATIONS.....	51
6.4 EXAMPLES OF TEMPERATURE COMPENSATION CIRCUITS (FOR REFERENCE ONLY).....	51

# 1 FUNCTION AND STRUCTURE

## 1.1 General

DMC series is the name given to the dot matrix character LCD display modules that have been developed by OPTREX CORPORATION. The modules consist of high contrast and large viewing angle TN and STN type LC (liquid crystal) panels. Each module contains a CMOS controller and all necessary drivers which have low power consumption. The controller is equipped with an internal character generator ROM, RAM and RAM for display data. All display functions are controllable by instructions making interfacing practical.

Both display data RAM and character generator RAM can be read making it possible to use any part not used for display as general data RAM. The products of this series therefore have wide application possibilities in the field of terminal display or display for measuring devices.

## 1.2 Characteristics

- 1.2.1 5 x 7 dots plus cursor, 5 x 8 dots or 5 x 11 dots, dot matrix LCD (TN and STN mode.)
- 1.2.2 4 bit or 8 bit interface with MPU is possible.
- 1.2.3 Display data RAM 80 x bit (max. 80 characters)
- 1.2.4 Character generator ROM 160 5 x 7 Character fonts.  
32 5 x 10 Character fonts.  
Custom ROM codes available.
- 1.2.5 Character generator RAM Program write (64 x 8 bit)  
8 5 x 7 character fonts.  
4 5 x 10 character fonts.
- 1.2.6 Both display data RAM and Character generator RAM can be read from MPU.
- 1.2.7 Duty ratio 1 Line Display: 1/8 duty 5 x 7 dots plus cursor, 5 x 8 dots.  
1/11 duty 5 x 11 dots.  
1/16 duty 5 x 7 dots plus cursor, 5 x 8 dots.  
2 Line Display: 1/16 duty 5 x 7 dots plus cursor, 5 x 8 dots.  
4 Line Display: 1/16 duty 5 x 8 dots.
- 1.2.8 Wide variety of operating instructions:  
  
Display clear, Cursor home, Display ON/OFF, Display cursor blink, Cursor shift, Display shift.

- 1.2.9 Internal automatic reset circuit upon power up.
- 1.2.10 Internal oscillator circuit.
- 1.2.11 CMOS circuitry.
- 1.2.12 Logic power source: Single (+5 V) for normal temperature.  
Dual voltage for extended temperature.
- 1.2.13 Operating temperature range: 0 to +50°C (Standard type)  
-20 to +70°C ("H" type)

### **1.3 Handling Precautions**

1. LCD panel is made of glass. Avoid subjecting to strong mechanical shock or applying strong pressure on to the surface of display area.
2. The polarizer used on the surface of display panel is easily scratched and damaged. Precautions should be taken when handling.
3. CMOS-LSI is used for module circuit therefore your attention is called to the following:
  - a) All unused input terminals should be connected to Vcc or GND. The selection of Vcc or GND will depend upon which connection will satisfy the desired logical function.
  - b) When power source voltage is not applied avoid applying input signal.
  - c) Anti-static electricity measures:
    - i) When working with modules, either use your naked or gloved hand and wear non-conductive work suit to prevent generating static electricity by friction. ESD ground straps should be utilized.
    - ii) Floors, doors, and work tables must be grounded to discharge electricity.
    - iii) Tools such as soldering iron, cutting pliers and tweezers should be either grounded or properly treated whenever necessary.
4. For long term storage, avoid places of high temperature and humidity or direct sunlight.
5. Caution should be taken not to get the liquid crystal fluid in one's mouth or hands if a panel is broken. If this occurs, immediately wash with water.

## 1.4 List of DMC Series

**Table 1.1**

	Display Format Characters x Lines	Character Font Hort'l x Vertical	Duty	Module Size W x H x T (mm)	View Area W x H (mm)	Character Size W x H (mm)	Dot Size W x H (mm)	Available Variations
DMC-16105	16 x 1	5 x 8	1/16	80.0 x 36.0 x 15.0	64.5 x 13	3.2 x 5.95	0.6 x 0.7	NY-LY
DMC-16106A	16 x 1	5 x 11	1/11	EL B/L 80.0 x 36.0 x 10.3 Standard 80.0 x 36.0 x 10.0	64.5 x 13.8 64.5 x 13.0	3.2 x 8.2	0.6 x 0.7	E, H, HU, HE
DMC-16117	16 x 1	5 x 8	1/16	EL B/L 80.0 x 36.0 x 10.3 Standard 80.0 x 36.0 x 10.0	64.5 x 26.3	3.2 x 5.95	0.6 x 0.7	A, H, HE AN, AN-B, ANY, AN-EB
DMC-16128	16 x 1	5 x 8	1/16	LED 122.0 x 33.0 x 15.7 Reflective 122.0 x 33.0 x 11.0	99 x 13	4.84 x 9.66	0.92 x 1.1	N-LY NY-LY
DMC-16129	16 x 1	5 x 8	1/8	122.0 x 33.0 x 11.0	154.0 x 15.3	4.84 x 9.66	0.92 x 1.1	H U
DMC-16188	16 x 1	5 x 8	1/8	LED 151.0 x 40.0 x 14.2 Reflective & EL 151.0 x 40.0 x 10.0	120.0 x 23.0	6.0 x 14.54	1.152 x 1.765	NY-LY NYU-LY
DMC-16202	16 x 2	5 x 8	1/16	84.0 x 45.0 x 15.1	61.0 x 31.5	2.95 x 5.55	0.55 x 0.65	LY N-LY-B NY-LY NYJ-LY-D
DMC-16204	16 x 2	5 x 8	1/16	LED 80.0 x 40.0 x 16.1 Reflective & EL 80.0 x 40.0 x 10.9	59.5 x 16	2.95 x 5.55	0.55 x 0.65	NY-LY U-LY
DMC-16205	16 x 2	5 x 8	1/16	88.0 x 34.0 x 16.1	59.5 x 16.0	2.95 x 5.55	0.55 x 0.65	NY-LY
DMC-16207	16 x 2	5 x 8	1/16	84.0 x 44.0 x 11.0	61.0 x 16.0	2.95 x 5.55	0.55 x 0.65	* H* N* N-B* N-EB* NY-B U*
DMC-16230	16 x 2	5 x 8	1/16	LED 122.0 x 44.0 x 14.6 Reflective & EL 122.0 x 44.0 x 11.0	99.0 x 36.0	4.84 x 9.66	0.92 x 1.1	E H H-LY N N-EB NY NY-LY NY-LY-B



								NYJ-LYD NYU-LY U
DMC-16249	16 x 2	5 x 8	1/16	80.0 x 36.0 x 11.0	64.5 x 13.8	2.95 x 4.35	0.55 x 0.5	B* N* UB*
DMC-16266								V-YGR
DMC-16433	16 x 4	5 x 8	1/16	87.0 x 60.0 x 11.0	61.8 x 25.2	2.95 x 4.75	0.55 x 0.55	E H N N-B N-EB N-SEW-B NU-EB NY-SEB-B
DMC-20171	20 x 1	5 x 8	1/8	LED 182 x 33.5 x 14.35max Reflective 182 x 33.5 x 12.7max	154.3 x 15.3	6.7 x 11.5	1.3 x 1.3	E NY-LY
DMC-20215	20 x 2	5 x 8	1/16	116.0 x 44.0 x 11	83.0 x 18.6	3.2 x 5.55	0.6 x 0.65	
DMC-20261	20 x 2	5 x 8	1/16	LED 116.0 x 37.0 x 15.7max Reflective 116.0 x 37.0 x 11.0	83.0 x 18.6	3.2 x 5.55	0.6 x 0.65	ANY-LY-B N N-E NY-LY NYJ-LY-D
DMC-20434	20 x 4	5 x 8	1/16	98.5 x 60.0 x 11.0	76.0 x 25.2	2.95 x 4.75	0.55 x 0.55	E H HE N N-B N-EB N-SEW NY-EB U
DMC-20481	20 x 4	5 x 8	1/16	98.5 x 61.0 x 15.6	76.0 x 25.2	2.95 x 4.75	0.55 x 0.55	NY-LY NY-LY-B NYU-LY
DMC-2079	40 x 2	5 x 8	1/16	172.0 x 33.5 x 15.5	142.5 x 16.5	3.2 x 5.55	0.6 x 0.65	LY1 NB-LY-B NY-LY-B
DMC-24227	24 x 2	5 x 8	1/16	118.0 x 36.0 x 11.0	93.5 x 15.8	3.2 x 5.55	0.6 x 0.65	N N-B N-EB
DMC-32132	32 x 1	5 x 11	1/11	174.5 x 31.0 x 11.0	123.5 x 16.5	3.2 x 8.2	0.6 x 0.7	UE
DMC-32239	32 x 2	5 x 8	1/16	174.5 x 31.0 x 11.0	141.0 x 29.7	3.45 x 11.75	0.65 x 0.65	NE
DMC-40131	40 x 1	5 x 11	1/11	182.0 x 33.5 x 11.0	152.5 x 16.5	3.2 x 8.2	0.6 x 0.7	
DMC-40202	40 x 2	5 x 8	1/16	182.0 x 34.5 x 15.1	142.5 x 16.5	3.2 x 5.55	0.6 x 0.65	N-LY-B NY-LY

								NY-LY-B
DMC-40205								NY-LY-B
DMC-40218	40 x 2	5 x 8	1/16	182.0 x 33.5 x 11.0	152.5 x 16.5	3.2 x 5.55	0.6 x 0.65	N N-EB N-SEW-B NY NY-EB
DMC-40267								NY-LY NYJ-LY
DMC-40457	40 x 4	5 x 8	1/16	LED 190 x 54 x 13.6 Reflective 190 x 54 x 11.0	147 x 29.5	2.78 x 4.89	0.5 x 0.55	N N-B N-EB NY-LY NY-LYB NYJ-LYD
DMC-50097	16 x 2	5 x 8	1/16	84.0 x 44.0 x 11.0	61.0 x 16.0	2.95 x 5.55	0.55 x 0.65	H
DMC-50149	24 x 2	5 x 8	1/16	121.5 x 33.5 x 16.1	93.5 x 15.8	3.2 x 5.55	0.6 x 0.65	NYU-LY-B
DMC-50218	20 x 2	5 x 8	1/16	LED 116.0 x 37.0 x 15.7 Reflective 116.0 x 37.0 x 11.0	83.0 x 18.6	3.2 x 5.55	0.6 x 0.65	N-B
DMC-50244	20 x 4	5 x 8	1/16	82.5max x 4.8max x 9.5	71.6 x 25.2	2.95 x 4.75	0.55 x 0.55	N-B
DMC-50292								NY-LY-B
DMC-50448	8 x 2	5 x 8	1/16	40.0 x 35.4 x 8.2	30.4 x 13.9	2.95 x 4.75	0.55 x 0.55	N

## 1.5 Pin Assignments

**Table 1.2**

Pin Number	Symbol
1	V <sub>ss</sub>
2	V <sub>cc</sub>
3	V <sub>ee</sub>
4	RS
5	R/W
6	E
7	DB0
8	DB1
9	DB2
10	DB3
11	DB4
12	DB5
13	DB6
14	DB7

### Pin Descriptions:

**Table 1.3 List of terminal functions**

Signal name	No. of Lines	Input/Output	Connected to	Function
DB4 ~ DB7	4	Input/Output	MPU	4 lines of high order data bus. Bi-directional transfer of data between MPU and module is done through these lines. Also DB <sub>7</sub> can be used as a busy flag. These lines are used as data in 4 bit operation.
DB0 ~ DB3	4	Input/Output	MPU	4 lines of low order data bus. Bi-directional transfer of data between MPU and module is done through these lines. In 4 bit operation, these are not used and should be grounded.
E	1	Input	MPU	Enable - Operation start signal for data read/write.
R/W	1	Input	MPU	Signal to select Read or Write "0": Write "1": Read
RS	1	Input	MPU	Register Select "0": Instruction register (Write) : Busy flag; Address counter (Read) "1": Data register (Write, Read)
V <sub>ee</sub>	1		Power Supply	Terminal for LCD drive power source.
V <sub>cc</sub>	1		Power Supply	+5V
V <sub>ss</sub>	1		Power Supply	0V (GND)
E1	1	Input	MPU	Enable 1 - Operation start signal for data Read/Write of upper 2 lines. Applicable to DMC 40457 series only.
E2	1	Input	MPU	Enable 2 - Operation start signal for data Read/Write of lower 2 lines. Applicable to DMC 40457 series only.

1.6 Block Diagram

Figure 1.1

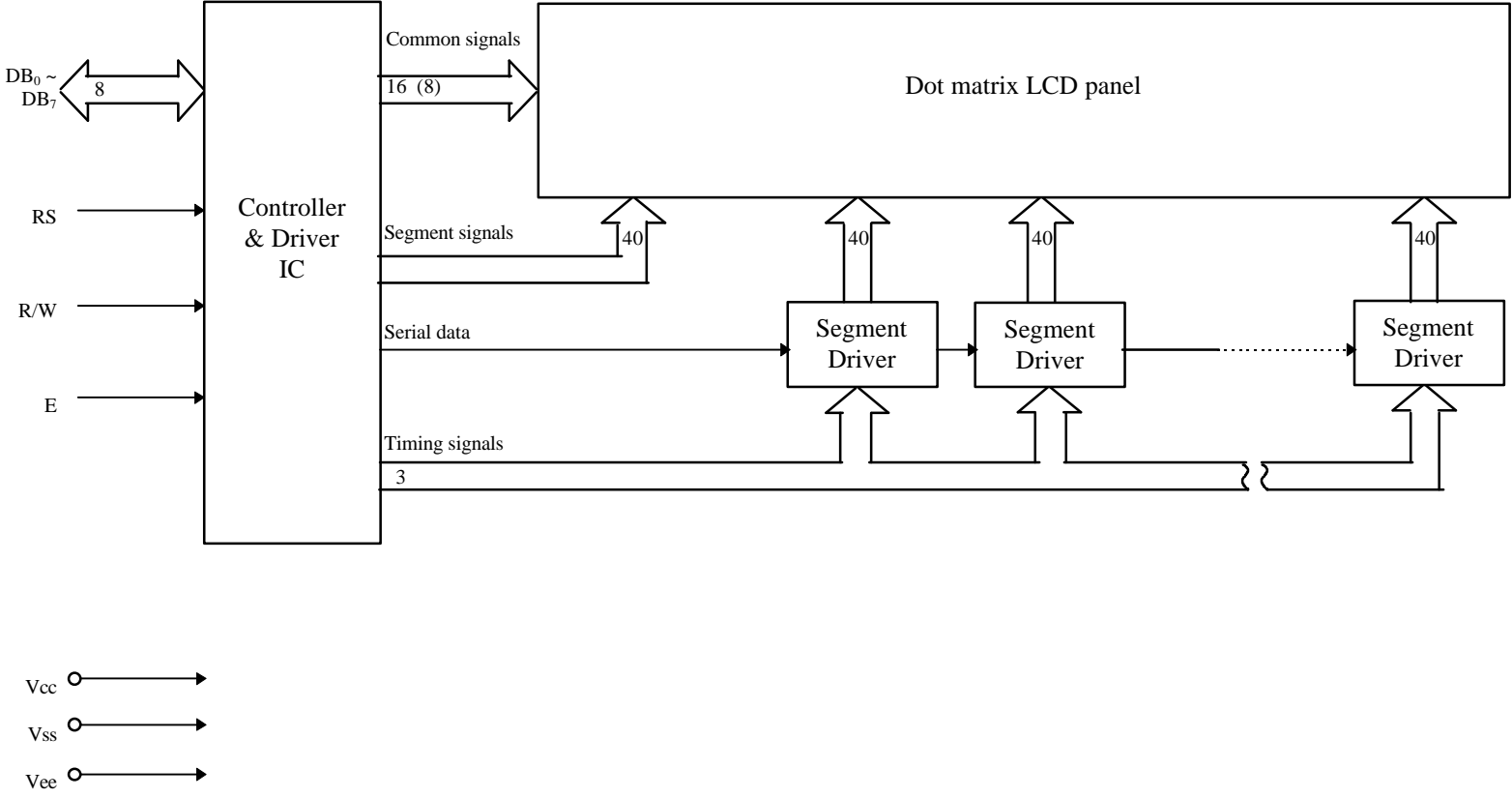

## 1.7 Explanation of Internal Operation

### 1.7.1 Register

The Controller for the DMC series has two 8 bit registers, the Instruction register (IR) and the data register (DR).

The IR is a write only register to store instruction codes like Display Clear or Cursor Shift as well as addresses for the Display Data RAM (DD RAM) or the Character Generator RAM (CG RAM).

The DR is a read/write register used for temporarily storing data to be read/written to/from the DD RAM or CG RAM.

Data written into the DR is automatically written into DD RAM or CG RAM by an internal operation of the display controller.

The DR is also used to store data when reading out data from DD RAM or CG RAM. When address information is written into IR, data is read out from DD RAM or CG RAM to DR by an internal operation. Data transfer is then completed by reading the DR.

After performing a read from the DR, data in the DD RAM or CG RAM at the next address is sent to the DR for the next read cycle. The register select (RS) signal determines which of these two registers is selected.

**Table 1.4**  
**Selection of Registers**

RS	R/W	Operation
0	0	IR write, internal operation (Display Clear etc.)
0	1	Busy flag (DB <sub>7</sub> ) and Address Counter (DB <sub>0</sub> ~ DB <sub>6</sub> ) read
1	0	DR Write, Internal Operation (DR ~ DD RAM or CG RAM)
1	1	DR Read, Internal Operation (DD RAM or CG RAM)

### 1.7.2 Busy Flag (BF)

When the busy flag is high or “1” the module is performing an internal operation and the next instruction will not be accepted. As shown in Table 1.4, the busy flag outputs to DB<sub>7</sub> when RS=0 and a read operation is performed. The next instruction must not be written until ensuring that the busy flag is low or “0”.

### 1.7.3 Address Counter (AC)

The address counter (AC) assigns addresses to the DD RAM and the CG RAM.

When the address of an instruction is written into the IR, the address information is sent from the IR to the AC. The selection of either DD RAM or CG RAM is also determined concurrently by the same instruction.

After writing into or reading from the DD RAM or CG RAM the address counter (AC) is automatically incremented by 1 or decremented by 1 (determined by the I/D bit in the “Entry Mode Set” command.) AC contents are output to DB<sub>0</sub> ~ DB<sub>7</sub> when RS = 0 and a read operation is performed, as shown in Table 1.4.

### 1.7.4 Display Data RAM (DD RAM)

The Display Data RAM (DD RAM) stores the display data represented in 8 bit character codes. Its capacity is 80 x 8 bits or 80 characters. The Display Data RAM that is not used for the display can be used as a general data RAM.

### 1.7.5 Address Counter (AC)

The DD RAM address (ADD) is set in the Address Counter (AC) and is represented in hexadecimal notation.

The address counter can be written using the “Set DD RAM Address” instruction and can be read using the “Read Busy Flag and Address” instruction. In each case, data bits D<sub>0</sub>-D<sub>6</sub> represent the DD RAM address. In the read operation, bit D<sub>7</sub> represents the “Busy Flag”.

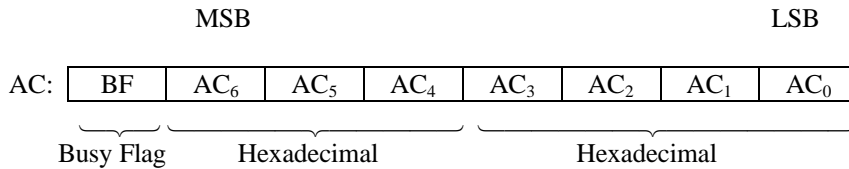

Example 1 DD RAM address “4E”

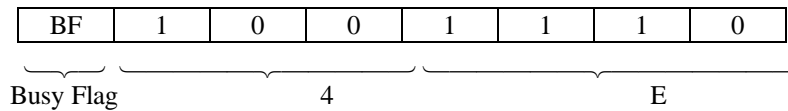

## 1.7.6 DD RAM Addressing

### 1.7.6.1 SINGLE LINE DISPLAYS (1/8 duty)

The relationship of a DD RAM address to the actual character position of a particular display varies.

For most single line displays, the addressing is sequential starting at address 00H as the far left character and incrementing as you move each character position to the right.

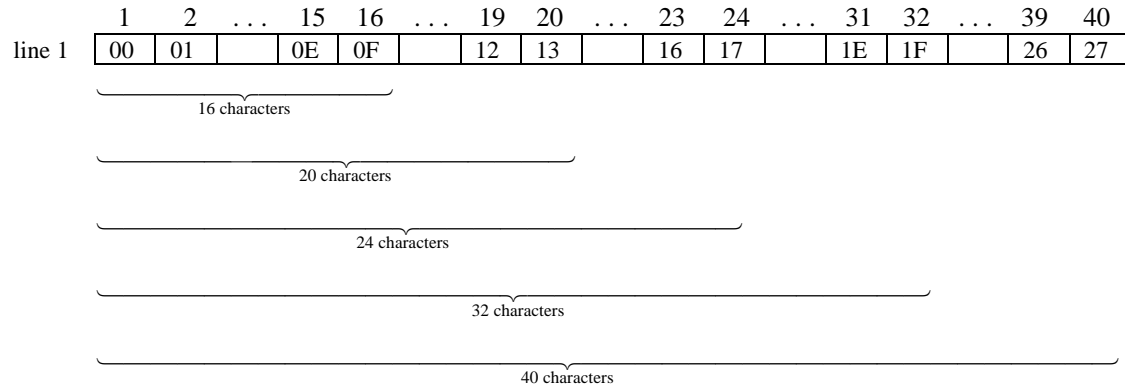

When the display shift operation is performed on single line displays, the window of the display is shifted either right or left within the full 80 byte DD RAM area.

For example:

A left display shift operation shifts the display/DD RAM as follows:

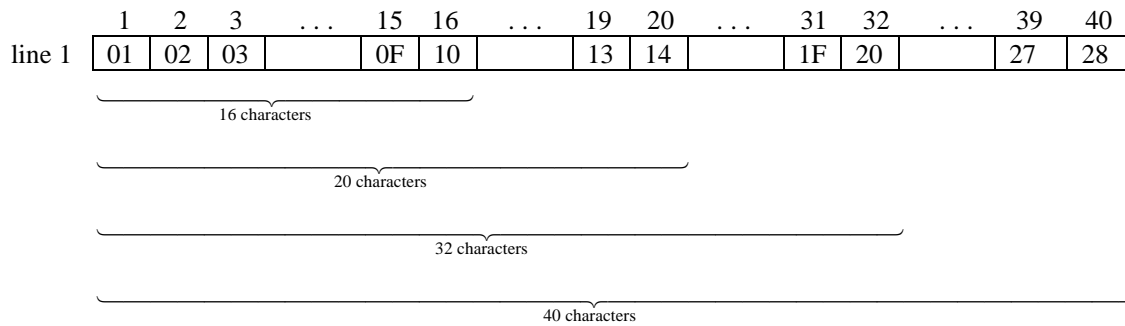

A right display shift operation shifts the display/DD RAM as follows:

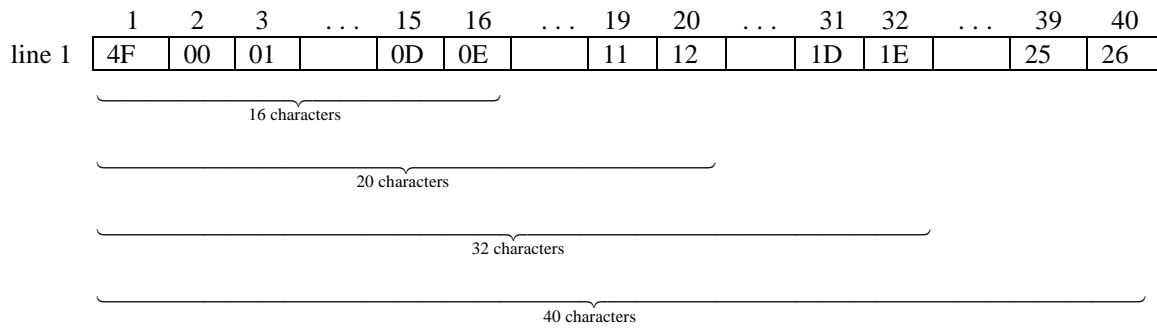

Note: When a display shift operation is performed on a single line display, the display window is incremented or decremented through the entire 80 byte DD RAM.

**1.7.6.2 SINGLE LINE DISPLAYS (1/16 duty)**

16 character x 1 line displays (1/16 duty)

In order to properly address these modules, they must be operated as 8 character x 2 line displays where the first 8 characters represent line 1 and the last 8 represent line 2.

For example:

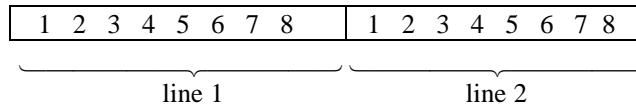

The addressing for these types of displays is as follows.

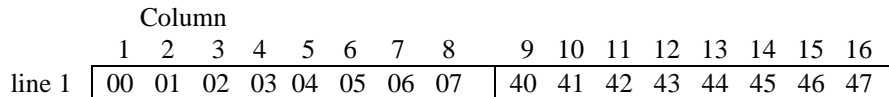



If the display shift operation is performed, each half of the display shifts simultaneously.

For example:

Left Shift Operation

	Column															
	1	2	3	4	5	6	7	8	9	10	11	12	13	14	15	16
line 1	01	02	03	04	05	06	07	08	41	42	43	44	45	46	47	48

Right Shift Operation

	Column															
	1	2	3	4	5	6	7	8	9	10	11	12	13	14	15	16
line 1	27	00	01	02	03	04	05	06	67	40	41	42	43	44	45	46

**1.7.6.3 TWO LINE DISPLAYS**

The available two line displays range from 8 characters per line up to 40 characters per line.

In any case, the display addressing begins at address 00H for line 1 and address 40H for line 2.

8 character x 2 line displays (1/16 duty)

	Column							
	1	2	3	4	5	6	7	8
line 1	00	01	02	03	04	05	06	07
line 2	40	41	42	43	44	45	46	47

16 character through 40 character x 2 line display (1/16 duty)

	Column															
	1	2	3	...	15	16	...	19	20	...	31	32	...	38	39	40
line 1	00	01	02		0E	0F		12	13		1E	1F		25	26	27
line 2	40	41	42		4E	4F		52	53		5E	5F		65	66	67

When the display shift operation is performed on two line displays, each line is shifted independently.

For example:

A left display shift operation shifts the display as follows:

	Column															
	1	2	3	...	15	16	...	19	20	...	31	32	...	38	39	40
line 1	01	02	03		0F	10		13	14		1F	20		26	27	00
line 2	41	42	43		4F	50		53	54		5F	60		66	67	40

16 characters
   
20 characters
   
32 characters
   
40 characters

A right display shift operation shifts the display as follows:

	Column															
	1	2	3	...	15	16	...	19	20	...	31	32	...	38	39	40
line 1	27	00	01		0D	0E		11	12		1D	1E		24	25	26
line 2	67	40	41		4D	4E		51	52		5D	5E		64	65	66

16 characters
   
20 characters
   
32 characters
   
40 characters

**1.7.6.4 FOUR LINE DISPLAYS: With 20 characters or less per line.**

Four line displays with 20 characters or less per line operate the same as a two line display with twice as many characters per line

For example:

A 20 character x 4 line display operates the same as a 40 character x 2 line display.

This is shown below in each addressing scheme:

16 character x 4 lines (1/16 duty)

	Column						
	1	2	3	...	14	15	16
line 1	00	01	02		0D	0E	0F
line 2	40	41	42		4D	4E	4F
line 3	10	11	12		1D	1E	1F
line 4	50	51	52		4D	4E	4F

If the display shift operation is used, the addressing is shifted as follows:

**Left Shift**

	Column						
	1	2	3	...	14	15	16
line 1	01	02	03		0E	0F	10
line 2	41	42	43		4E	4F	50
line 3	11	12	13		1E	1F	20
line 4	51	52	53		5E	5F	60

**Right Shift**

	Column						
	1	2	3	...	14	15	16
line 1	27	00	01		0C	0D	0E
line 2	67	40	41		4C	4D	4E
line 3	0F	10	11		1C	1D	1E
line 4	4F	50	51		5C	5D	5E

20 character x 4 lines (1/16 duty)

	Column						
	1	2	3	...	18	19	20
line 1	00	01	02		13	14	15
line 2	40	41	42		53	54	55
line 3	16	17	18		25	26	27
line 4	56	57	58		65	66	67

If the display shift operation is used on a 20 x 4 display, the addressing is shifted as follows:

### Left Shift

	Column						
	1	2	3	...	18	19	20
line 1	01	02	03		12	13	14
line 2	41	42	43		52	53	54
line 3	15	16	17		25	26	27
line 4	55	56	57		65	66	67

### Right Shift

	Column						
	1	2	3	...	18	19	20
line 1	27	00	01		10	11	12
line 2	67	40	41		50	51	52
line 3	13	14	15		24	25	26
line 4	53	54	55		64	65	66

#### 1.7.6.5 **FOUR LINE DISPLAYS: With more than 20 characters per line.**

40 characters x 4 lines (1/16 duty x 2)

Four line displays with more than 20 characters per line (i.e. 40 characters x 4 lines) operate as two separate 40 character x 2 line displays.

	Column						
	1	2	3	...	38	39	40
line 1	00	01	02		25	26	27
line 2	40	41	42		65	66	67
line 3	00	01	02		25	26	27
line 4	40	41	42		65	66	67

If the display shift operation is used on a 40 x 4 display, the addressing is shifted as follows:

### Left Shift

	Column							
	1	2	3	...	38	39	40	
line 1	01	02	03		26	27	00	} Upper half
line 2	41	42	43		66	67	40	
line 3	01	02	03		26	27	00	} Lower half
line 4	41	42	43		66	67	40	

### Right Shift

	Column							
	1	2	3	...	38	39	40	
line 1	27	00	01		24	25	26	} Upper half
line 2	67	40	41		64	65	66	
line 3	27	00	01		24	25	26	} Lower half
line 4	67	40	41		64	65	66	

The display shift operation can be performed on either the upper or lower half of the display independently of the other.

In either case, the display shift operation is exactly the same as the display shift operation on the 40 x 2 line display.

Notice that when display shift operations are performed, the 16 character display window is shifted through the full 80 byte DD RAM area.

### 1.7.7 Character Generator ROM (CG ROM)

The Character Generator Read Only Memory (CG ROM) is an 80 x 8 bit ROM capable of generating 160 types of 5 x 7 dot or 32 types or 5 x 10 dot character patterns from an 8 bit character code. 5 x 10 character patterns cannot be utilized on all character display modules. Table 5.3 shows the standard character font table.

Custom CG ROM tables can be obtained if necessary. Please contact your local Optrex sales representative for details.

### 1.7.8 Character Generator RAM (CG RAM)

The CG RAM is a 64 x 8 bit RAM in which the user can program custom character patterns. Either 8 - 5 x 7 character patterns or 4 - 5 x 10 character patterns can be written.

To write previously programmed characters from the CG RAM to the DD RAM, character codes 0H through 7H are used. (See character font table 5.3)

The relationships between CG RAM address and data and the displayed character is shown in tables 5.1 and 5.2 respectively. Unused CG RAM locations can be used for general purpose RAM.

To program a 5 x 8 character pattern into the CG RAM location #2, the following steps should be taken.

- A. Use the “Set CG RAM address” command to position the CG RAM pointer to the n<sup>th</sup> row of character #2.

Ex.

RS	R/W	DB <sub>7</sub>	DB <sub>6</sub>	. . .	DB <sub>1</sub>	DB <sub>0</sub>			
0	0	0	1	0	0	1	Y	Y	Y
<span style="font-size: small;">Set CG RAM Address Command</span>				<span style="font-size: small;">Character Location #2</span>			<span style="font-size: small;">n<sup>th</sup> row of character #2 (initially YYY=000)</span>		

- B. Use the “Write Data to CG or DD RAM” Command to write the top row of the custom character.

Ex.

RS	R/W	DB <sub>7</sub>	DB <sub>6</sub>	. . .	DB <sub>1</sub>	DB <sub>0</sub>			
1	0	x	x	x	y	y	y	y	y
<span style="font-size: small;">Write Data Command</span>		<span style="font-size: small;">Don't Care</span>			<span style="font-size: small;">5 bits of character bit pattern for row n of 7.</span>				

C. The YYY portion of the “Set CG RAM address” command used in step 1 is auto incremented if the I/O bit is set in the “Entry Mode Set” command. When this is the case, return to step 2 until all rows of the character are written.

D. After writing all 7 rows of data, use the “Set DD RAM address” command to return the address counter to a DD RAM location.

E. To display the custom character written above, use the “Write Data to CG or DD RAM” command with the write data being 02H to display the character in the DD RAM address used in step 4.

Ex.

RS	R/W	DB <sub>7</sub>	DB <sub>6</sub>		. . .			DB <sub>1</sub>	DB <sub>0</sub>
1	0	0	0	0	0	0	0	0	1

**Table 5.1**

Relation between CG RAM address, character codes (DD RAM) and character patterns

Character code (DD RAM data)								CG RAM address								Character pattern (CG RAM data)																			
7	6	5	4	3	2	1	0	5	4	3	2	1	0	7	6	5	4	3	2	1	0														
←Higher order bit				Lower order→ bit				←Higher order bit				Lower order→ bit				←Higher order bit				Lower order→ bit															
0 0 0 0 * 0 0 0								0 0 0								0	0	0	0	↑	1	1	1	1	0	↓	Example of character (1)								
																0	0	1	0		1	0	0	0	1										
																0	1	0	0		1	0	0	0	1										
																0	1	1	0		1	1	1	1	0										
																1	0	0	0		1	0	1	0	0										
																1	0	1	0		1	0	0	1	0										
																1	1	0	0		1	0	0	0	1										
0 0 0 0 * 0 0 1								0 0 1								0	0	0	0	↑	1	0	0	0	1	↓	Example of character (2)								
																0	0	1	0		0	1	0	1	0										
																0	1	0	0		1	1	1	1	1										
																0	1	1	0		0	0	1	0	0										
																1	0	0	0		1	1	1	1	1										
																1	0	1	0		0	0	1	0	0										
																1	1	0	0		0	0	1	0	0										
0 0 0 0 * 1 1 1								1 1 1								0	0	0	0	↑	* means Don't care.														
																0	0	1																	
																1	0	1																	
																1	1	0																	
																1	1	1																	
																*	*	*																	
																*	*	*																	

Notes:

- Character code bits 0 ~ 2 correspond to CG RAM address bit 3 ~ 5. (3 bits: 8 types)
  - CG RAM address bits 0 ~ 2 designate the line position within a character pattern. The 8<sup>th</sup> line is the cursor position and display is determined by the logical OR of the 8<sup>th</sup> line and the cursor. Maintain the 8<sup>th</sup> line data, corresponding to the cursor display position, in the “0” state for cursor display. When the 8<sup>th</sup> line data is “1” bit 1 lights up regardless of cursor existence.
  - Character pattern row positions correspond to CG RAM data bits 0 ~ 4 as shown in the figure (bit 4 being at the left end).
- Since CG RAM data bits 5 ~ 7 are not used for display, they can be used for the general data RAM as memory still exists.
- As shown in Table 5.1, CG RAM character patterns are selected when character code bits 4 ~ 7 are all “0”. However as character code bit 3 is an ineffective bit the “R” display in the character pattern example is selected by character code “00” (hexadecimal) or “08” (hexadecimal).
  - “1” for CG RAM data corresponds to selected pixels and “0” for non selected.

**Table 5.2**

Relation between CG RAM address, character codes (DD RAM) and character patterns

Character code (DD RAM data)								CG RAM address								Character pattern (CG RAM data)																								
7	6	5	4	3	2	1	0	5	4	3	2	1	0	7	6	5	4	3	2	1	0																			
←Higher order bit				Lower order→ bit				←Higher order bit				Lower order→ bit				←Higher order bit				Lower order→ bit																				
0 0 0 0 * 0 0 0								0 0								0	0	0	0	0	0	*	*	*	0	0	0	0	0	0	0	0	0	0	0	0	0	0	0	0
																0	0	0	1	0	0	0	0	1	0	1	1	0	0	0	0	1	0	1	1	0	0	0	0	
																0	0	1	0	0	0	0	0	0	1	0	0	0	0	0	0	1	1	0	0	0	0	0	1	
																0	1	0	0	1	0	0	0	0	1	0	1	0	0	0	0	1	0	0	0	0	0	0	1	
																0	1	1	0	0	0	0	0	0	1	1	0	0	0	0	0	1	1	1	1	0	0	0	0	
																1	0	0	0	0	0	0	0	1	0	0	0	0	0	0	0	1	0	0	0	0	0	0	0	
																1	0	0	0	1	0	0	0	1	0	0	1	0	0	0	0	1	0	0	0	0	0	0	0	
																1	0	1	0	0	0	0	0	1	0	1	0	0	0	0	0	0	0	0	0	0	0	0	0	
0 0 0 0 * 0 0 1								0 0								1	0	1	1	1	1	*	*	*	* * * * *	* * * * *														
																1	1	0	0	0	0	0	0	* * *	* * *															
																1	1	0	1	0	0	0	0	* * *	* * *															
																1	1	1	0	0	0	0	0	* * *	* * *															
0 0 0 0 * 1 1 *								1 1								0	0	0	0	0	0	*	*	*	* * *	* * *														
																1	0	0	1	0	0	0	0	* * *	* * *															
0 0 0 0 * 1 1 *								1 1								1	0	1	1	1	1	*	*	*	* * *	* * *														
																1	1	0	0	0	0	0	0	* * *	* * *															
																1	1	0	1	0	0	0	0	* * *	* * *															
																1	1	1	0	0	0	0	0	* * *	* * *															

Example of character pattern  
← Cursor position

\* means Don't care.

Note:

- Character code bits 1,2 correspond to CG RAM address bit 4, 5 (2 bits: 4 types)
  - CG RAM address bits 0 ~ 3 designate the line position within a character pattern. The 11<sup>th</sup> line is the cursor position and display is determined by the logical OR of the 11<sup>th</sup> line and the cursor. Maintain the 11<sup>th</sup> line data, corresponding to the cursor display position, in the "0" state for cursor display. When the 11<sup>th</sup> line data is "1" bit 1 lights up regardless of cursor existence.
  - Character pattern row positions are the same as 5 x 7 dot character pattern positions.
- Since CG RAM data bits 5 ~ 7 are not used for display, they can be used for the general data RAM as memory still exits.
- As shown in Table 5.2, CG RAM character patterns are selected when character code bits 4 ~ 7 are all "0". However, since character code bit 0 and 3 are ineffective bits, the display of character pattern example is selected by character code "00" "01" "08" "09" (hexadecimal).
  - "1" for CG RAM data corresponds to selected pixels and "0" for non selected.



**Table 5.3**  
Standard Character Font Table

High order bit \ Low order bit	0000	0010	0011	0100	0101	0110	0111	1010	1011	1100	1101	1110	1111
X X X X0000	CG RAM (1)		0	a	P	`	P	—	9	E		e	p
	(2)	!	1	A	O	a	9	■	7	チ	△	ä	q
X X X X0010	(3)	"	2	B	R	b	r	「	イ	ウ	×	ß	θ
	(4)	#	3	C	S	c	s	」	ウ	テ	E	e	ω
X X X X0100	(5)	\$	4	D	T	d	t	、	エ	ト	ホ	μ	α
	(6)	%	5	E	U	e	u	・	オ	ナ	工	ε	ü
X X X X0110	(7)	&	6	F	V	f	v	ヲ	カ	ニ	ヨ	ρ	Σ
	(8)	'	7	G	W	g	w	フ	キ	ヌ	ラ	g	π
X X X X1000	(1)	(	8	H	X	h	x	イ	ウ	ホ	リ	γ	α
	(2)	)	9	I	Y	i	y	ウ	ケ	リ	ル	“	γ
X X X X1010	(3)	*	:	J	Z	j	z	エ	コ	ハ	レ	j	φ
	(4)	+	;	K	C	k	c	オ	サ	ヒ	ロ	*	κ
X X X X1100	(5)	,	<	L	¥	l	l	ホ	シ	フ	ワ	φ	κ
	(6)	—	=	M	I	m	)	ユ	ズ	ハ	コ	ε	÷
	(7)	■	>	N	^	n	→	ヨ	セ	ホ	“	ñ	
	(8)	/	?	O	_	o	+	ウ	リ	マ	”	ö	

Note: Character of high order bit 1110 and 1111 may be inadequate.

## 2 MPU INTERFACING

### 2.1 General

Each character display can be operated in either 4 or 8 bit mode.

Instructions/Data are written to the display using the signal timing characteristics found in section 4.2.

When operating in 4 bit mode, data is transferred in two 4 bit operations using data bits DB<sub>4</sub> - DB<sub>7</sub>. DB<sub>0</sub> - DB<sub>3</sub> are not used and should be tied low. When using 4 bit mode, data is transferred twice before the instruction cycle is complete. First the high order nibble is transferred then the low order nibble. The busy flag should only be checked after both nibbles are transferred.

When operating in 8 bit mode, data is transferred using the full 8 bit bus DB<sub>0</sub> - DB<sub>7</sub>.

### 2.2 Initialization

#### 2.2.1 Initialization using the Internal Reset Circuit

The display can be initialized using the internal reset circuit if the Internal Power Supply Reset timing below is met.

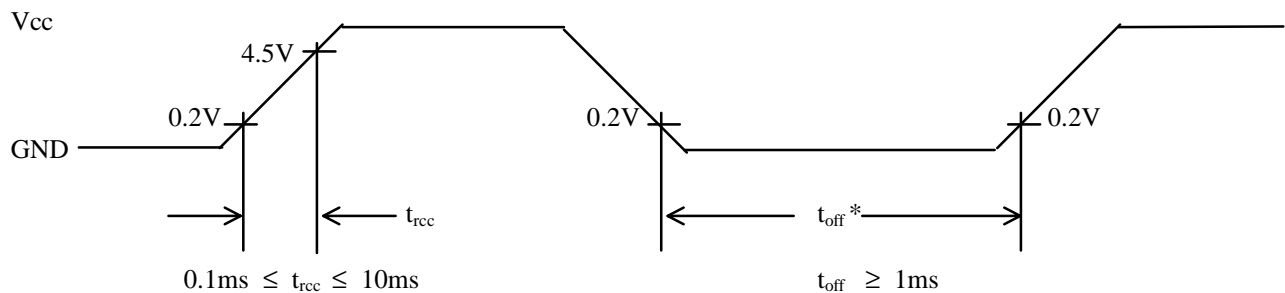

Note:  $t_{off}$  represents the time of power off condition for a momentary power supply dip or when cycling power off then on.

If the above conditions are met, the busy flag will go active 10ms after  $V_{cc}$  rises to 4.5V. The busy flag will remain active until the following instructions are executed fully.

a. Display Clear

b. Function set:

DL = 1 : 8 bit interface operation  
N = 0 : 1 - line display  
F = 0 : 5 x 7 dot character font

c. Display ON/OFF Control:

D = 0 : Display OFF  
C = 0 : Cursor OFF  
B = 0 : Blink OFF

d. Entry Mode Set:

I/D = 1 : +1 (Increment Mode)  
S = 0 : No Display Shift operation

If the internal power supply reset timing cannot be met, the display will not operate normally. In this case, the display can be initialized through software.

Note: Variable power supply loading can have an effect on power supply reset timing. If this is the case, then the software initialization should be performed.

### 2.2.2 Software Initialization

Although software initialization is not mandatory, it is recommended that this procedure always be performed. When the internal power supply reset timing cannot be met, then the display must be initialized using one of the following procedures.

2.2.2.1 8 - Bit Initialization:

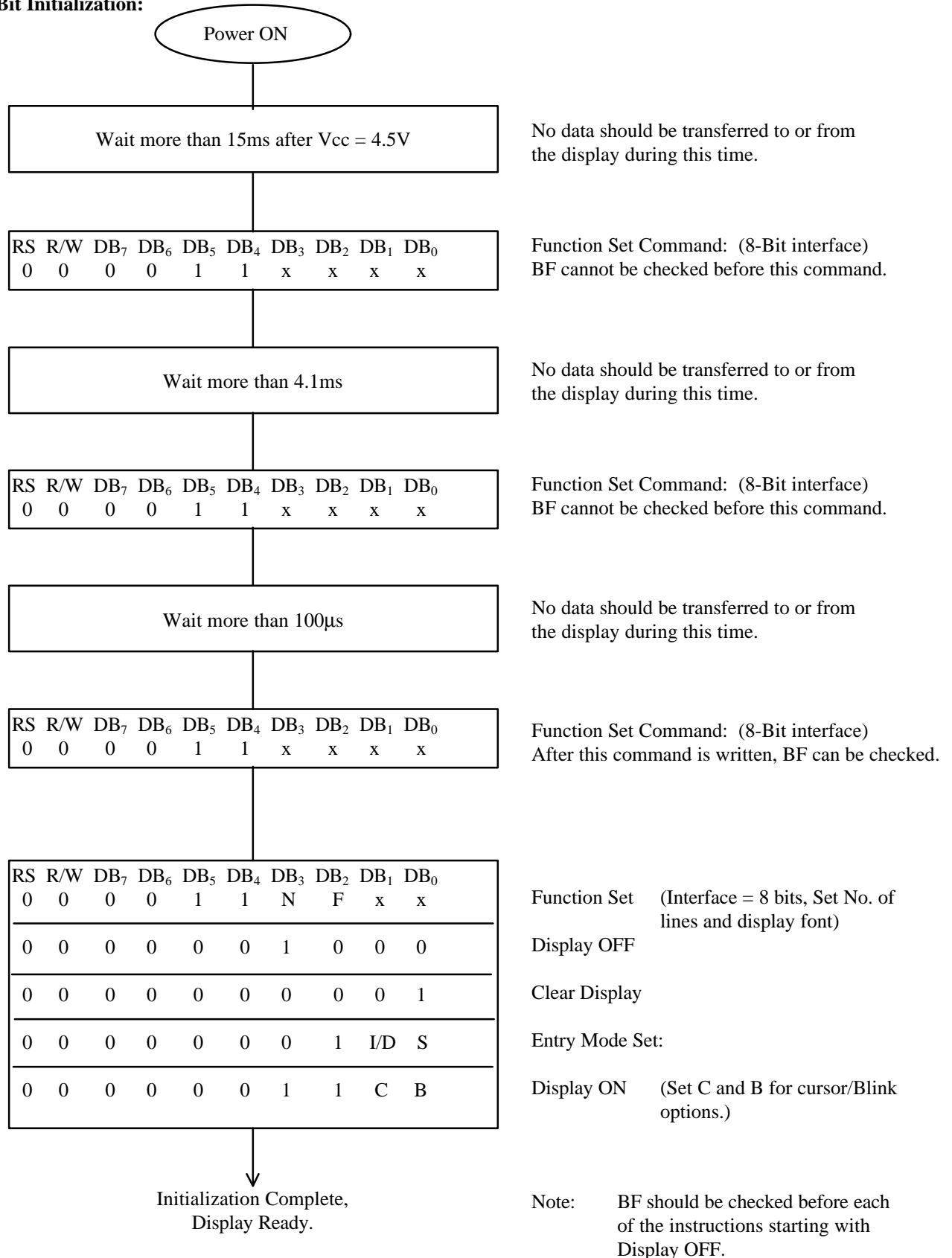

2.2.2.2 4 - Bit Initialization:

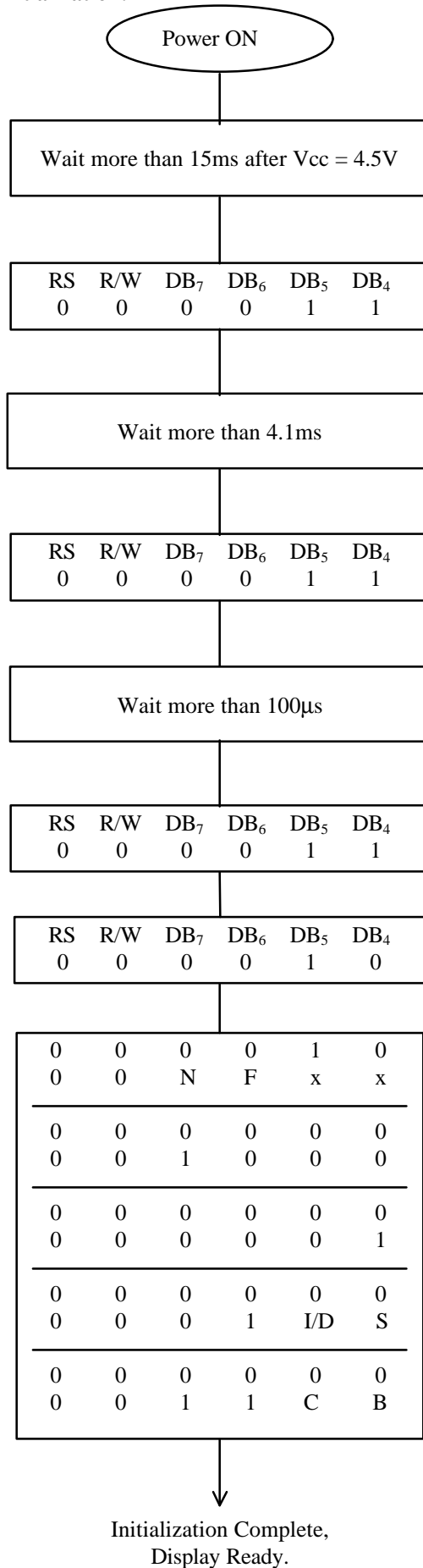

No data should be transferred to or from the display during this time.

Function Set Command: (8-Bit interface)

No data should be transferred to or from the display during this time.

Function Set Command: (8-Bit interface)

No data should be transferred to or from the display during this time.

Function Set Command: (8-Bit interface)  
After this command is written, BF can be checked.

Function Set: Sets interface to 4-bit

Function Set (Interface = 4-bit, Set N and F for number of lines and character font)

Display OFF

Clear Display

Entry Mode Set:

Display ON (Set C and B for cursor/Blink options.)

Note: BF should be checked before each of the instructions starting with Display OFF.

### 3 INSTRUCTIONS

Table 3.1 shows the list of instructions recognized by the LCD Controller and their execution times. If the busy flag is not checked, each instruction must be allotted at least the execution time before writing another instruction or data. After writing these execution times, the display can be written without conflict.

#### 3.1 Detailed Explanations

##### 3.1.1 Clear Display

	RS	R/W	DB <sub>7</sub>	DB <sub>6</sub>	. . .			DB <sub>1</sub>	DB <sub>0</sub>
Code	0	0	0	0	0	0	0	0	1

Writes the space code “20” (hexadecimal) into all addresses of DD RAM. Returns display to its original position if it was shifted. In other words the display clears and the cursor or blink moves to the upper left edge of the display. The execution of clear display instruction sets entry mode to increment mode.

##### 3.1.2 Return Home

	RS	R/W	DB <sub>7</sub>	DB <sub>6</sub>	. . .			DB <sub>1</sub>	DB <sub>0</sub>
Code	0	0	0	0	0	0	0	1	x

Note: x = Don't Care

Sets the DD RAM address “0” in address counter. Return display to its original position if it was shifted. DD RAM contents do not change.

The cursor or the blink moves to the upper left edge of the display. Text on the display remains unchanged.

##### 3.1.3 Entry mode set

	RS	S/W	DB <sub>7</sub>	DB <sub>6</sub>	. . .			DB <sub>1</sub>	DB <sub>0</sub>
Code	0	0	0	0	0	0	1	I/D	S

Sets the Increment/Decrement and Shift modes to the desired settings.

I/D: Increments (I/D = 1) or decrements (ID = 0) the DD RAM address by 1 when a character code is written into or read from the DD RAM.

The cursor or blink moves to the right when incremented by +1.

The same applies to writing and reading the CG RAM.

S: Shifts the entire display either to the right or to the left when S = 1; shift to the left when I/D = 1 and to the right when I/D = 0. Thus it looks as if the cursor stands still and only the display seems to move.

The display does not shift when reading from DD RAM nor when S = 0.

### 3.1.4 Display ON/OFF Control

	RS	R/W	DB <sub>7</sub>	DB <sub>6</sub>	. . .	DB <sub>1</sub>	DB <sub>0</sub>
Code	0	0	0	0	0	1	D C B

Controls the display ON/OFF status, Cursor ON/OFF and Cursor Blink function.

D: The display is ON when D = 1 and OFF when D = 0. When OFF due to D = 0, display data remains in the DD RAM. It can be displayed immediately by setting D = 1.

C: The cursor displays when C = 1 and does not display when C = 0. The cursor is displayed on the 8<sup>th</sup> line when 5 x 7 dot character font has been selected.

B: The character indicated by the cursor blinks when B = 1. The blink is displayed by switching between all blank dots and display characters at 0.4 sec intervals.

The cursor and the blink can be set to display simultaneously.

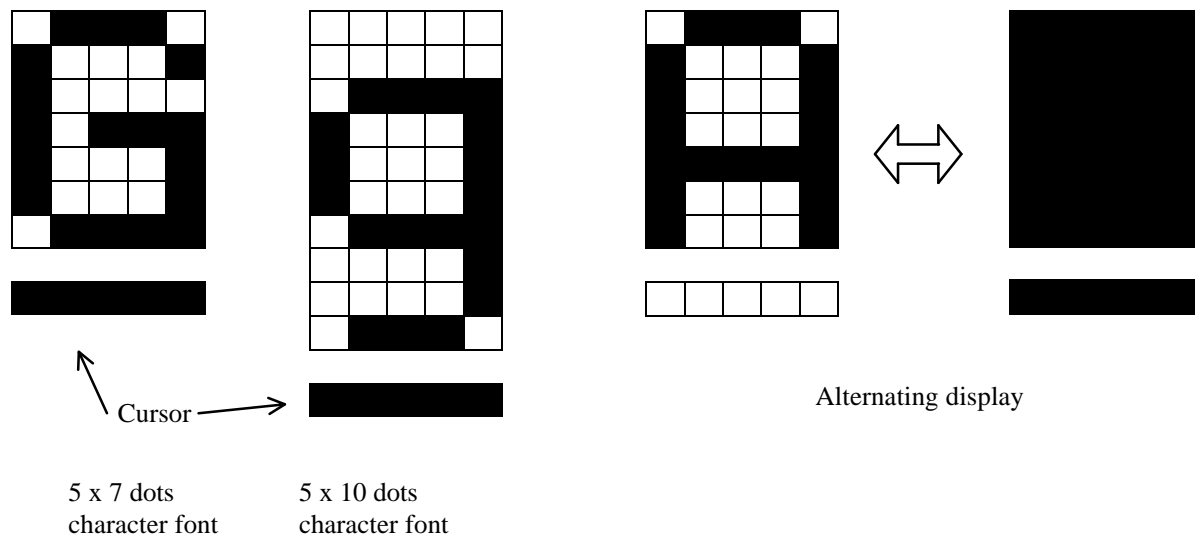

(a) Cursor display example  
C = 1 ; B = 0

(b) Blink display example  
C = 1 ; B = 1

### 3.1.5 Cursor or Display Shift

	RS	R/W	DB <sub>7</sub>	DB <sub>6</sub>	. . .			DB <sub>1</sub>	DB <sub>0</sub>	
Code	0	0	0	0	0	1	S/C	R/L	x	x

Note: x = Don't Care

Shifts the cursor position or display to the right or left without writing or reading display data. This function is used to correct or search for the display. In a 2-line display the cursor moves to the 2<sup>nd</sup> line when it passes the 40<sup>th</sup> digit of the 1<sup>st</sup> line. Notice that the 1<sup>st</sup> and 2<sup>nd</sup> line displays will shift at the same time.

When the displayed data is shifted repeatedly each line only moves horizontally but the 2<sup>nd</sup> line display does not shift into the 1<sup>st</sup> line position.

S/C	R/L	
0	0	Shifts cursor position to the left (AC is decremented by one)
0	1	Shifts cursor position to the right (AC is incremented by one)
1	0	Shifts the entire display to the left. The cursor follows the display shift.
1	1	Shifts the entire display to the right. The cursor follows the display shift.

The contents of Address Counter (AC) do not change if the only action performed is shifting display.

### 3.1.6 Function Set

Sets the interface data length, the number of lines, and character font.

	RS	R/W	DB <sub>7</sub>	DB <sub>6</sub>	. . .			DB <sub>1</sub>	DB <sub>0</sub>	
Code	0	0	0	0	1	DL	N	F	x	x

Note: x = Don't Care

DL: Sets interface data length. Data is sent or received in 8-bit length (DB<sub>7</sub> ~ DB<sub>0</sub>) when DL = "1", and in 4-bit length (DB<sub>7</sub> ~ DB<sub>4</sub>) when DL = 0. When the 4-bit length is selected, data must be sent or received twice.

N: Sets the number of lines

N = "0" : 1 line display (1/8 duty)

N = "1" : 2 line display (1/16 duty)

F: Sets character font.

F = "1" : 5 x 10 dots

F = "0" : 5 x 7 dots

Note: Perform the function at the head of the program before executing all instructions (except Busy flag/address read). From this point, the function set instruction cannot be executed other than to change interface length.



### 3.1.7 Set CG RAM Address

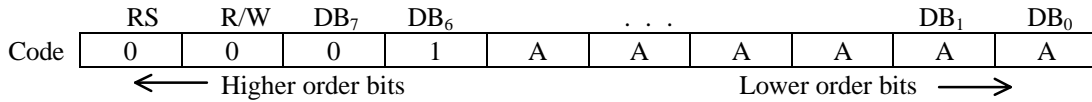

Sets the address counter to the CG RAM address AAAAAAA. Data is then written/read to from the CG RAM.

### 3.1.8 Set DD RAM Address

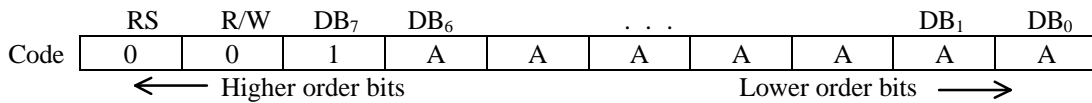

Sets the address counter to the DD RAM address AAAAAAA. Data is then written/read to from the DD RAM.

For a 1-line display module AAAAAAA is “00” ~ “4F” (hexadecimal). For 2-line display module AAAAAAA is “00” ~ “27” (hexadecimal) for the first line and “40” ~ “67” (hexadecimal) for the second line. (See section 1.7.6 “DD RAM addressing”)

### 3.1.9 Read Busy Flag and Address

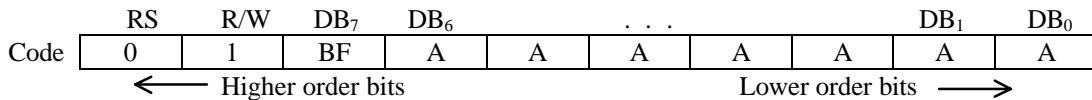

Reads the busy flag (BF) and value of the address counter (AC). BF = 1 indicates that on internal operation is in progress and the next instruction will not be accepted until BF is set to “0”. If the display is written while BF = 1, abnormal operation will occur.

The BF status should be checked before each write operation.

At the same time the value of the address counter expressed in binary AAAAAAA is read out. The address counter is used by both CG and DD RAM and its value is determined by the previous instruction. Address contents are the same as in sections 3.1.7 and 3.1.8.

### 3.1.10 Write Data to CG or DD RAM

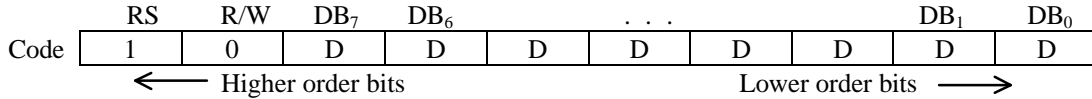

Writes binary 8-bit data DDDDDDDD to the CG or DD RAM.

The previous designation determines whether the CG or DD RAM is to be written (CG RAM address set or DD RAM address set). After a write the entry mode will automatically increase or decrease the address by 1. Display shift will also follow the entry mode.

### 3.1.11 Read Data from CG or DD RAM

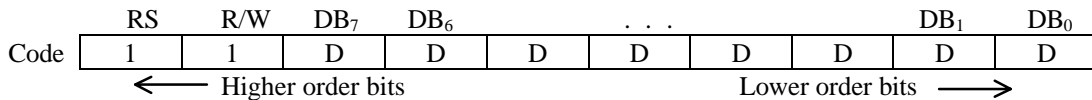

Reads binary 8-bit data DDDDDDDD from the CG RAM or DD RAM.

The previous designation determines whether the CG or DD RAM is to be read.

Before entering the read instruction, you must execute either the CG RAM or DD RAM address set instruction.

If you don't, the first read data will be invalidated. When serially executing the "read" instruction the next address data is normally read from the second read.

The "address set" instruction need not be executed just before the "read" instruction when shifting the cursor using cursor instruction (when reading DD RAM). The cursor shift instruction operation is the same as that of the DD RAM address set instruction.

After a read, the entry mode automatically increases or decreases the address by 1; however, display shift is not executed no matter what the entry mode is.

Note: The address counter (AC) is automatically incremented or decremented by 1 after a "write" instruction to either CG RAM or DD RAM. RAM data selected by the AC cannot then be read out even if "read" instructions are executed.

The conditions for correct data reads are: (a) Execute either the address set instruction or cursor shift instruction (only with DD RAM) or (b) The execution of the "read data" instruction from the second time when the read instruction is performed multiple times in serial.



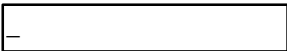
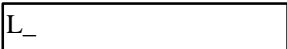

**Table 3.1**  
**List of Instructions**







Instruction	Code										Description	Execution time (max.) when fcp or fosc is 250 kHz	
	RS	R/W	DB <sub>7</sub>	DB <sub>6</sub>	DB <sub>5</sub>	DB <sub>4</sub>	DB <sub>3</sub>	DB <sub>2</sub>	DB <sub>1</sub>	DB <sub>0</sub>			
Clear Display	0	0	0	0	0	0	0	0	0	0	1	Clears entire display and sets DD RAM address 0 in address counter.	15.2ms
Return Home	0	0	0	0	0	0	0	0	0	1	x	Sets DD RAM address 0 in address counter. Also returns shifted display to original position. DD RAM contents remain unchanged.	15.2ms
Entry Mode Set	0	0	0	0	0	0	0	0	1	I/D	S	Sets cursor move direction and specifies shift or display. These operations are performed during data write and read.	40μs
Display ON/OFF Control	0	0	0	0	0	0	1	D	C	B		Sets ON/OFF of entire display (D), cursor ON/OFF (C), and blink of cursor position character (B).	40μs
Cursor or Display Shift	0	0	0	0	0	1	S/C	R/L	x	x		Moves cursor and shifts display without changing DD RAM contents.	40μs
Function Set	0	0	0	0	1	DL	N	F	x	x		Sets interface data length (DL), number of display lines (N) and character font (F).	40μs
Set CG RAM Address	0	0	0	1	ACG							Sets CG RAM address. CG RAM data is sent and received after this setting.	40μs
Set DD RAM Address	0	0	1	ADD							Sets DD RAM address. DD RAM data is sent and received after this setting.	40μs	
Read Busy Flag & Address	0	1	BF	AC							Reads busy flag (BF) indicating internal operation is being performed and reads address counter contents.	40μs	
Write Data to CG or DD RAM	1	0	Write Data							Writes data into DD RAM or CG RAM.	40μs		
Read Data from CG or DD RAM	1	1	Read Data							Reads data from DD RAM or CG RAM.	40μs		
	I/D=1 : Increment I/D=0 : Decrement S=1 : Accompanies display shift S/C=1 : Display shift S/C=0 : Cursor move R/L=1 : Shift to the right R/L=0 : Shifts to the left DL=1 : 8 bits, DL=0 : 4 bits N=1 : 2 lines, N=0 : 1 line F=1 : 5x10 dots, F=0 : 5x7 dots BF=1 : Internally operating BF=0 : Can accept instruction										DD RAM : Display Data RAM CG RAM : Character Generator RAM ACG : CG RAM address ADD : DD RAM address. Corresponds to cursor address. AC : Address counter used for both DD and CG RAM address.	Execution time changes when frequency changes.  Example: When fcp or fosc is 270kHz: $40\mu s \times 250/270 = 37 \mu s$	



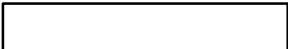

x = don't care. (No Effect)

### 3.2 Examples of Instructions

#### 3.2.1 16 Character x 1 Line Display (1/8 duty) Using CG RAM

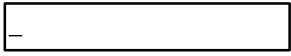
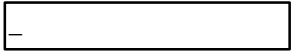
No.	Instruction	Display	Operation																									
1	Power supply ON (Initialized by Internal reset circuit) <table border="1"> <tr> <td>RS</td> <td>R/W</td> <td>DB<sub>7</sub></td> <td>~</td> <td>DB<sub>0</sub></td> </tr> <tr> <td>/</td> <td>/</td> <td></td> <td></td> <td></td> </tr> </table>	RS	R/W	DB <sub>7</sub>	~	DB <sub>0</sub>	/	/					Module is initialized. No display appears.															
RS	R/W	DB <sub>7</sub>	~	DB <sub>0</sub>																								
/	/																											
2	Function set <table border="1"> <tr> <td>RS</td> <td>R/W</td> <td>DB<sub>7</sub></td> <td>~</td> <td>DB<sub>0</sub></td> </tr> <tr> <td>0</td> <td>0</td> <td>0</td> <td>0</td> <td>1</td> </tr> <tr> <td></td> <td></td> <td>1</td> <td>1</td> <td>0</td> </tr> <tr> <td></td> <td></td> <td>0</td> <td>0</td> <td>*</td> </tr> <tr> <td></td> <td></td> <td></td> <td></td> <td>*</td> </tr> </table>	RS	R/W	DB <sub>7</sub>	~	DB <sub>0</sub>	0	0	0	0	1			1	1	0			0	0	*					*		Sets 8 bit interface data length, selects 5 x 7 dots, 1-line display
RS	R/W	DB <sub>7</sub>	~	DB <sub>0</sub>																								
0	0	0	0	1																								
		1	1	0																								
		0	0	*																								
				*																								
3	Display ON/OFF Control <table border="1"> <tr> <td>RS</td> <td>R/W</td> <td>DB<sub>7</sub></td> <td>~</td> <td>DB<sub>0</sub></td> </tr> <tr> <td>0</td> <td>0</td> <td>0</td> <td>0</td> <td>0</td> </tr> <tr> <td></td> <td></td> <td>0</td> <td>0</td> <td>1</td> </tr> <tr> <td></td> <td></td> <td>1</td> <td>1</td> <td>1</td> </tr> <tr> <td></td> <td></td> <td>0</td> <td></td> <td>0</td> </tr> </table>	RS	R/W	DB <sub>7</sub>	~	DB <sub>0</sub>	0	0	0	0	0			0	0	1			1	1	1			0		0		Turns on display and cursor. No display appears.
RS	R/W	DB <sub>7</sub>	~	DB <sub>0</sub>																								
0	0	0	0	0																								
		0	0	1																								
		1	1	1																								
		0		0																								
4	Entry mode set <table border="1"> <tr> <td>RS</td> <td>R/W</td> <td>DB<sub>7</sub></td> <td>~</td> <td>DB<sub>0</sub></td> </tr> <tr> <td>0</td> <td>0</td> <td>0</td> <td>0</td> <td>0</td> </tr> <tr> <td></td> <td></td> <td>0</td> <td>0</td> <td>0</td> </tr> <tr> <td></td> <td></td> <td>0</td> <td>1</td> <td>1</td> </tr> <tr> <td></td> <td></td> <td>0</td> <td></td> <td>0</td> </tr> </table>	RS	R/W	DB <sub>7</sub>	~	DB <sub>0</sub>	0	0	0	0	0			0	0	0			0	1	1			0		0		Sets mode to increment the address by one and to shift cursor to the right at the time of write to internal RAM.
RS	R/W	DB <sub>7</sub>	~	DB <sub>0</sub>																								
0	0	0	0	0																								
		0	0	0																								
		0	1	1																								
		0		0																								
5	Write data to CG/DD RAM <table border="1"> <tr> <td>RS</td> <td>R/W</td> <td>DB<sub>7</sub></td> <td>~</td> <td>DB<sub>0</sub></td> </tr> <tr> <td>1</td> <td>0</td> <td>0</td> <td>1</td> <td>0</td> </tr> <tr> <td></td> <td></td> <td>0</td> <td>1</td> <td>1</td> </tr> <tr> <td></td> <td></td> <td>0</td> <td>1</td> <td>0</td> </tr> <tr> <td></td> <td></td> <td>0</td> <td></td> <td>0</td> </tr> </table>	RS	R/W	DB <sub>7</sub>	~	DB <sub>0</sub>	1	0	0	1	0			0	1	1			0	1	0			0		0		Writes "L" cursor is incremented and moves to the right.
RS	R/W	DB <sub>7</sub>	~	DB <sub>0</sub>																								
1	0	0	1	0																								
		0	1	1																								
		0	1	0																								
		0		0																								
6	Write data to CG/DD RAM <table border="1"> <tr> <td>RS</td> <td>R/W</td> <td>DB<sub>7</sub></td> <td>~</td> <td>DB<sub>0</sub></td> </tr> <tr> <td>1</td> <td>0</td> <td>0</td> <td>1</td> <td>0</td> </tr> <tr> <td></td> <td></td> <td>0</td> <td>0</td> <td>0</td> </tr> <tr> <td></td> <td></td> <td>0</td> <td>0</td> <td>1</td> </tr> <tr> <td></td> <td></td> <td>1</td> <td></td> <td>1</td> </tr> </table>	RS	R/W	DB <sub>7</sub>	~	DB <sub>0</sub>	1	0	0	1	0			0	0	0			0	0	1			1		1		Writes "C"
RS	R/W	DB <sub>7</sub>	~	DB <sub>0</sub>																								
1	0	0	1	0																								
		0	0	0																								
		0	0	1																								
		1		1																								
7	⋮	⋮																										
8	Write data to CG/DD RAM <table border="1"> <tr> <td>RS</td> <td>R/W</td> <td>DB<sub>7</sub></td> <td>~</td> <td>DB<sub>0</sub></td> </tr> <tr> <td>1</td> <td>0</td> <td>0</td> <td>0</td> <td>1</td> </tr> <tr> <td></td> <td></td> <td>1</td> <td>1</td> <td>0</td> </tr> <tr> <td></td> <td></td> <td>1</td> <td>1</td> <td>0</td> </tr> <tr> <td></td> <td></td> <td>0</td> <td></td> <td>0</td> </tr> </table>	RS	R/W	DB <sub>7</sub>	~	DB <sub>0</sub>	1	0	0	0	1			1	1	0			1	1	0			0		0		Writes "6" cursor disappears. (DD RAM address is 10H)
RS	R/W	DB <sub>7</sub>	~	DB <sub>0</sub>																								
1	0	0	0	1																								
		1	1	0																								
		1	1	0																								
		0		0																								

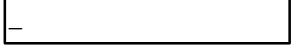
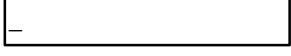
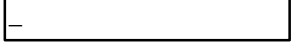
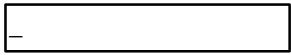
No.	Instruction	Display	Operation										
9	DD RAM address set <table border="1"> <tr> <td>RS</td> <td>R/W</td> <td>DB<sub>7</sub></td> <td>~</td> <td>DB<sub>0</sub></td> </tr> <tr> <td>0</td> <td>0</td> <td>1</td> <td>0 0 0 0 0 0 0</td> <td>0</td> </tr> </table>	RS	R/W	DB <sub>7</sub>	~	DB <sub>0</sub>	0	0	1	0 0 0 0 0 0 0	0		Cursor appears at home position
RS	R/W	DB <sub>7</sub>	~	DB <sub>0</sub>									
0	0	1	0 0 0 0 0 0 0	0									
10	Cursor/Display shift <table border="1"> <tr> <td>RS</td> <td>R/W</td> <td>DB<sub>7</sub></td> <td>~</td> <td>DB<sub>0</sub></td> </tr> <tr> <td>0</td> <td>0</td> <td>0 0 0</td> <td>1 1 1</td> <td>* *</td> </tr> </table>	RS	R/W	DB <sub>7</sub>	~	DB <sub>0</sub>	0	0	0 0 0	1 1 1	* *		Entire display one digit to the right.
RS	R/W	DB <sub>7</sub>	~	DB <sub>0</sub>									
0	0	0 0 0	1 1 1	* *									
11	Cursor/Display shift <table border="1"> <tr> <td>RS</td> <td>R/W</td> <td>DB<sub>7</sub></td> <td>~</td> <td>DB<sub>0</sub></td> </tr> <tr> <td>0</td> <td>0</td> <td>0 0 0</td> <td>1 1 1</td> <td>* *</td> </tr> </table>	RS	R/W	DB <sub>7</sub>	~	DB <sub>0</sub>	0	0	0 0 0	1 1 1	* *		Entire display shifts one digit to the right.
RS	R/W	DB <sub>7</sub>	~	DB <sub>0</sub>									
0	0	0 0 0	1 1 1	* *									
12	Display ON/OFF cursor <table border="1"> <tr> <td>RS</td> <td>R/W</td> <td>DB<sub>7</sub></td> <td>~</td> <td>DB<sub>0</sub></td> </tr> <tr> <td>0</td> <td>0</td> <td>0 0 0 0</td> <td>1 0 0 0</td> <td>0</td> </tr> </table>	RS	R/W	DB <sub>7</sub>	~	DB <sub>0</sub>	0	0	0 0 0 0	1 0 0 0	0		Entire display disappears.
RS	R/W	DB <sub>7</sub>	~	DB <sub>0</sub>									
0	0	0 0 0 0	1 0 0 0	0									
13	Display ON/OFF <table border="1"> <tr> <td>RS</td> <td>R/W</td> <td>DB<sub>7</sub></td> <td>~</td> <td>DB<sub>0</sub></td> </tr> <tr> <td>0</td> <td>0</td> <td>0 0 0 0</td> <td>1 1 1 0</td> <td>0</td> </tr> </table>	RS	R/W	DB <sub>7</sub>	~	DB <sub>0</sub>	0	0	0 0 0 0	1 1 1 0	0		Entire display reappears.
RS	R/W	DB <sub>7</sub>	~	DB <sub>0</sub>									
0	0	0 0 0 0	1 1 1 0	0									
14	Cursor Home <table border="1"> <tr> <td>RS</td> <td>R/W</td> <td>DB<sub>7</sub></td> <td>~</td> <td>DB<sub>0</sub></td> </tr> <tr> <td>0</td> <td>0</td> <td>0 0 0 0 0 0</td> <td>1</td> <td>*</td> </tr> </table>	RS	R/W	DB <sub>7</sub>	~	DB <sub>0</sub>	0	0	0 0 0 0 0 0	1	*		Returns both cursor and display to original position.
RS	R/W	DB <sub>7</sub>	~	DB <sub>0</sub>									
0	0	0 0 0 0 0 0	1	*									
15	Display clear <table border="1"> <tr> <td>RS</td> <td>R/W</td> <td>DB<sub>7</sub></td> <td>~</td> <td>DB<sub>0</sub></td> </tr> <tr> <td>0</td> <td>0</td> <td>0 0 0 0 0 0 0</td> <td>0</td> <td>1</td> </tr> </table>	RS	R/W	DB <sub>7</sub>	~	DB <sub>0</sub>	0	0	0 0 0 0 0 0 0	0	1		Clears entire display except cursor.
RS	R/W	DB <sub>7</sub>	~	DB <sub>0</sub>									
0	0	0 0 0 0 0 0 0	0	1									
16	Set CG RAM address <table border="1"> <tr> <td>RS</td> <td>R/W</td> <td>DB<sub>7</sub></td> <td>~</td> <td>DB<sub>0</sub></td> </tr> <tr> <td>0</td> <td>0</td> <td>0 1 0 1</td> <td>0 0 0 0</td> <td>0</td> </tr> </table>	RS	R/W	DB <sub>7</sub>	~	DB <sub>0</sub>	0	0	0 1 0 1	0 0 0 0	0		Set CG RAM address pointer to top row of character 3.
RS	R/W	DB <sub>7</sub>	~	DB <sub>0</sub>									
0	0	0 1 0 1	0 0 0 0	0									

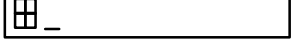
No.	Instruction	Display	Operation																									
17	Write data to CG RAM <table border="1"> <tr> <td>RS</td> <td>R/W</td> <td>DB<sub>7</sub></td> <td>~</td> <td>DB<sub>0</sub></td> </tr> <tr> <td>1</td> <td>0</td> <td>0</td> <td>0</td> <td>0</td> </tr> <tr> <td></td> <td></td> <td>1</td> <td>1</td> <td>1</td> </tr> <tr> <td></td> <td></td> <td>1</td> <td>1</td> <td>1</td> </tr> </table>	RS	R/W	DB <sub>7</sub>	~	DB <sub>0</sub>	1	0	0	0	0			1	1	1			1	1	1		Write top line of custom character to CG RAM					
RS	R/W	DB <sub>7</sub>	~	DB <sub>0</sub>																								
1	0	0	0	0																								
		1	1	1																								
		1	1	1																								
18	Write data to CG/DD RAM <table border="1"> <tr> <td>RS</td> <td>R/W</td> <td>DB<sub>7</sub></td> <td>~</td> <td>DB<sub>0</sub></td> </tr> <tr> <td>1</td> <td>0</td> <td>0</td> <td>0</td> <td>0</td> </tr> <tr> <td></td> <td></td> <td>1</td> <td>0</td> <td>1</td> </tr> <tr> <td></td> <td></td> <td>0</td> <td>1</td> <td>0</td> </tr> <tr> <td></td> <td></td> <td>1</td> <td>0</td> <td>1</td> </tr> </table>	RS	R/W	DB <sub>7</sub>	~	DB <sub>0</sub>	1	0	0	0	0			1	0	1			0	1	0			1	0	1		Write 2 <sup>nd</sup> line of custom character to CG RAM
RS	R/W	DB <sub>7</sub>	~	DB <sub>0</sub>																								
1	0	0	0	0																								
		1	0	1																								
		0	1	0																								
		1	0	1																								
19	Write data to CG/DD RAM <table border="1"> <tr> <td>RS</td> <td>R/W</td> <td>DB<sub>7</sub></td> <td>~</td> <td>DB<sub>0</sub></td> </tr> <tr> <td>1</td> <td>0</td> <td>0</td> <td>0</td> <td>0</td> </tr> <tr> <td></td> <td></td> <td>1</td> <td>0</td> <td>1</td> </tr> <tr> <td></td> <td></td> <td>0</td> <td>1</td> <td>0</td> </tr> <tr> <td></td> <td></td> <td>0</td> <td>0</td> <td>0</td> </tr> </table>	RS	R/W	DB <sub>7</sub>	~	DB <sub>0</sub>	1	0	0	0	0			1	0	1			0	1	0			0	0	0		Write 3 <sup>rd</sup> line of custom character to CG RAM
RS	R/W	DB <sub>7</sub>	~	DB <sub>0</sub>																								
1	0	0	0	0																								
		1	0	1																								
		0	1	0																								
		0	0	0																								
20	Write data to CG/DD RAM <table border="1"> <tr> <td>RS</td> <td>R/W</td> <td>DB<sub>7</sub></td> <td>~</td> <td>DB<sub>0</sub></td> </tr> <tr> <td>1</td> <td>0</td> <td>0</td> <td>0</td> <td>0</td> </tr> <tr> <td></td> <td></td> <td>1</td> <td>1</td> <td>1</td> </tr> <tr> <td></td> <td></td> <td>1</td> <td>1</td> <td>1</td> </tr> </table>	RS	R/W	DB <sub>7</sub>	~	DB <sub>0</sub>	1	0	0	0	0			1	1	1			1	1	1		Write 4 <sup>th</sup> line of custom character to CG RAM					
RS	R/W	DB <sub>7</sub>	~	DB <sub>0</sub>																								
1	0	0	0	0																								
		1	1	1																								
		1	1	1																								
21	Write data to CG/DD RAM <table border="1"> <tr> <td>RS</td> <td>R/W</td> <td>DB<sub>7</sub></td> <td>~</td> <td>DB<sub>0</sub></td> </tr> <tr> <td>1</td> <td>0</td> <td>0</td> <td>1</td> <td>0</td> </tr> <tr> <td></td> <td></td> <td>1</td> <td>0</td> <td>1</td> </tr> <tr> <td></td> <td></td> <td>0</td> <td>1</td> <td>0</td> </tr> <tr> <td></td> <td></td> <td>1</td> <td>0</td> <td>1</td> </tr> </table>	RS	R/W	DB <sub>7</sub>	~	DB <sub>0</sub>	1	0	0	1	0			1	0	1			0	1	0			1	0	1		Write 5 <sup>th</sup> line of custom character to CG RAM
RS	R/W	DB <sub>7</sub>	~	DB <sub>0</sub>																								
1	0	0	1	0																								
		1	0	1																								
		0	1	0																								
		1	0	1																								
22	Write data to CG/DD RAM <table border="1"> <tr> <td>RS</td> <td>R/W</td> <td>DB<sub>7</sub></td> <td>~</td> <td>DB<sub>0</sub></td> </tr> <tr> <td>1</td> <td>0</td> <td>0</td> <td>0</td> <td>0</td> </tr> <tr> <td></td> <td></td> <td>1</td> <td>0</td> <td>1</td> </tr> <tr> <td></td> <td></td> <td>0</td> <td>1</td> <td>0</td> </tr> <tr> <td></td> <td></td> <td>1</td> <td>0</td> <td>1</td> </tr> </table>	RS	R/W	DB <sub>7</sub>	~	DB <sub>0</sub>	1	0	0	0	0			1	0	1			0	1	0			1	0	1		Write 6 <sup>th</sup> line of custom character to CG RAM
RS	R/W	DB <sub>7</sub>	~	DB <sub>0</sub>																								
1	0	0	0	0																								
		1	0	1																								
		0	1	0																								
		1	0	1																								
23	Write data to CG/DD RAM <table border="1"> <tr> <td>RS</td> <td>R/W</td> <td>DB<sub>7</sub></td> <td>~</td> <td>DB<sub>0</sub></td> </tr> <tr> <td>1</td> <td>0</td> <td>0</td> <td>0</td> <td>0</td> </tr> <tr> <td></td> <td></td> <td>1</td> <td>1</td> <td>1</td> </tr> <tr> <td></td> <td></td> <td>1</td> <td>1</td> <td>1</td> </tr> </table>	RS	R/W	DB <sub>7</sub>	~	DB <sub>0</sub>	1	0	0	0	0			1	1	1			1	1	1		Write 7 <sup>th</sup> line of custom character to CG RAM					
RS	R/W	DB <sub>7</sub>	~	DB <sub>0</sub>																								
1	0	0	0	0																								
		1	1	1																								
		1	1	1																								
24	Set DD RAM address <table border="1"> <tr> <td>RS</td> <td>R/W</td> <td>DB<sub>7</sub></td> <td>~</td> <td>DB<sub>0</sub></td> </tr> <tr> <td>0</td> <td>0</td> <td>0</td> <td>0</td> <td>0</td> </tr> <tr> <td></td> <td></td> <td>0</td> <td>0</td> <td>0</td> </tr> <tr> <td></td> <td></td> <td>0</td> <td>0</td> <td>0</td> </tr> <tr> <td></td> <td></td> <td>0</td> <td>0</td> <td>0</td> </tr> </table>	RS	R/W	DB <sub>7</sub>	~	DB <sub>0</sub>	0	0	0	0	0			0	0	0			0	0	0			0	0	0		Set DD RAM address to first character position.
RS	R/W	DB <sub>7</sub>	~	DB <sub>0</sub>																								
0	0	0	0	0																								
		0	0	0																								
		0	0	0																								
		0	0	0																								
25	Write data to CG/DD RAM <table border="1"> <tr> <td>RS</td> <td>R/W</td> <td>DB<sub>7</sub></td> <td>~</td> <td>DB<sub>0</sub></td> </tr> <tr> <td>1</td> <td>0</td> <td>0</td> <td>0</td> <td>0</td> </tr> <tr> <td></td> <td></td> <td>0</td> <td>0</td> <td>0</td> </tr> <tr> <td></td> <td></td> <td>0</td> <td>0</td> <td>1</td> </tr> <tr> <td></td> <td></td> <td>0</td> <td>0</td> <td>0</td> </tr> </table>	RS	R/W	DB <sub>7</sub>	~	DB <sub>0</sub>	1	0	0	0	0			0	0	0			0	0	1			0	0	0		Writes previously programmed character to display. Cursor is incremented and moved to the right.
RS	R/W	DB <sub>7</sub>	~	DB <sub>0</sub>																								
1	0	0	0	0																								
		0	0	0																								
		0	0	1																								
		0	0	0																								



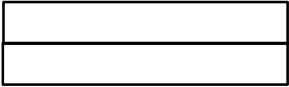
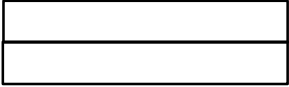
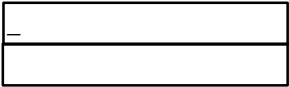
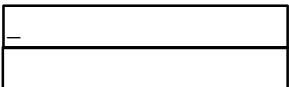
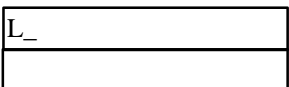
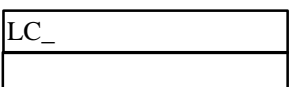
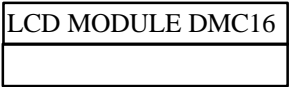

### 3.2.2 16 Character x 2 Line Display (1/16 duty)

No.	Instruction	Display	Operation										
1	Power supply ON (Initialized by Internal reset circuit) <table border="1" style="width: 100%; border-collapse: collapse;"> <tr> <td style="width: 10%;">RS</td> <td style="width: 10%;">R/W</td> <td style="width: 15%;">DB<sub>7</sub></td> <td style="width: 10%; text-align: center;">~</td> <td style="width: 15%;">DB<sub>0</sub></td> </tr> <tr> <td style="border: none;">/</td> <td style="border: none;">/</td> <td colspan="3"></td> </tr> </table>	RS	R/W	DB <sub>7</sub>	~	DB <sub>0</sub>	/	/					Module is initialized.
RS	R/W	DB <sub>7</sub>	~	DB <sub>0</sub>									
/	/												
2	Function set <table border="1" style="width: 100%; border-collapse: collapse;"> <tr> <td style="width: 10%;">RS</td> <td style="width: 10%;">R/W</td> <td style="width: 15%;">DB<sub>7</sub></td> <td style="width: 10%; text-align: center;">~</td> <td style="width: 15%;">DB<sub>0</sub></td> </tr> <tr> <td style="text-align: center;">0</td> <td style="text-align: center;">0</td> <td style="text-align: center;">0 0 1 1 1 0</td> <td style="text-align: center;">* *</td> <td></td> </tr> </table>	RS	R/W	DB <sub>7</sub>	~	DB <sub>0</sub>	0	0	0 0 1 1 1 0	* *			Sets the interface data length to 8 bits and selects 2-line display and 5 x 7-dot character font.
RS	R/W	DB <sub>7</sub>	~	DB <sub>0</sub>									
0	0	0 0 1 1 1 0	* *										
3	Display ON/OFF Control <table border="1" style="width: 100%; border-collapse: collapse;"> <tr> <td style="width: 10%;">RS</td> <td style="width: 10%;">R/W</td> <td style="width: 15%;">DB<sub>7</sub></td> <td style="width: 10%; text-align: center;">~</td> <td style="width: 15%;">DB<sub>0</sub></td> </tr> <tr> <td style="text-align: center;">0</td> <td style="text-align: center;">0</td> <td style="text-align: center;">0 0 0 0 1 1 1 0</td> <td></td> <td></td> </tr> </table>	RS	R/W	DB <sub>7</sub>	~	DB <sub>0</sub>	0	0	0 0 0 0 1 1 1 0				Turns on display and cursor.
RS	R/W	DB <sub>7</sub>	~	DB <sub>0</sub>									
0	0	0 0 0 0 1 1 1 0											
4	Entry mode set <table border="1" style="width: 100%; border-collapse: collapse;"> <tr> <td style="width: 10%;">RS</td> <td style="width: 10%;">R/W</td> <td style="width: 15%;">DB<sub>7</sub></td> <td style="width: 10%; text-align: center;">~</td> <td style="width: 15%;">DB<sub>0</sub></td> </tr> <tr> <td style="text-align: center;">0</td> <td style="text-align: center;">0</td> <td style="text-align: center;">0 0 0 0 0 1 1 0</td> <td></td> <td></td> </tr> </table>	RS	R/W	DB <sub>7</sub>	~	DB <sub>0</sub>	0	0	0 0 0 0 0 1 1 0				Sets mode to increment address by one and to shift the cursor to the right at the time of write to internal RAM
RS	R/W	DB <sub>7</sub>	~	DB <sub>0</sub>									
0	0	0 0 0 0 0 1 1 0											
5	Write data to CG/DD RAM <table border="1" style="width: 100%; border-collapse: collapse;"> <tr> <td style="width: 10%;">RS</td> <td style="width: 10%;">R/W</td> <td style="width: 15%;">DB<sub>7</sub></td> <td style="width: 10%; text-align: center;">~</td> <td style="width: 15%;">DB<sub>0</sub></td> </tr> <tr> <td style="text-align: center;">1</td> <td style="text-align: center;">0</td> <td style="text-align: center;">0 1 0 0 1 1 0 0</td> <td></td> <td></td> </tr> </table>	RS	R/W	DB <sub>7</sub>	~	DB <sub>0</sub>	1	0	0 1 0 0 1 1 0 0				Writes "L". Cursor is incremented by one and shifts to the right.
RS	R/W	DB <sub>7</sub>	~	DB <sub>0</sub>									
1	0	0 1 0 0 1 1 0 0											
6	Write data to CG/DD RAM <table border="1" style="width: 100%; border-collapse: collapse;"> <tr> <td style="width: 10%;">RS</td> <td style="width: 10%;">R/W</td> <td style="width: 15%;">DB<sub>7</sub></td> <td style="width: 10%; text-align: center;">~</td> <td style="width: 15%;">DB<sub>0</sub></td> </tr> <tr> <td style="text-align: center;">1</td> <td style="text-align: center;">0</td> <td style="text-align: center;">0 1 0 0 0 0 1 1</td> <td></td> <td></td> </tr> </table>	RS	R/W	DB <sub>7</sub>	~	DB <sub>0</sub>	1	0	0 1 0 0 0 0 1 1				Writes "C"
RS	R/W	DB <sub>7</sub>	~	DB <sub>0</sub>									
1	0	0 1 0 0 0 0 1 1											
7	⋮	⋮											
8	Write data to CG/DD RAM <table border="1" style="width: 100%; border-collapse: collapse;"> <tr> <td style="width: 10%;">RS</td> <td style="width: 10%;">R/W</td> <td style="width: 15%;">DB<sub>7</sub></td> <td style="width: 10%; text-align: center;">~</td> <td style="width: 15%;">DB<sub>0</sub></td> </tr> <tr> <td style="text-align: center;">1</td> <td style="text-align: center;">0</td> <td style="text-align: center;">0 0 1 1 0 1 1 0</td> <td></td> <td></td> </tr> </table>	RS	R/W	DB <sub>7</sub>	~	DB <sub>0</sub>	1	0	0 0 1 1 0 1 1 0				Writes "6"
RS	R/W	DB <sub>7</sub>	~	DB <sub>0</sub>									
1	0	0 0 1 1 0 1 1 0											

No.	Instruction	Display	Operation												
9	Set DD RAM address. <table border="1"> <tr> <td>RS</td> <td>R/W</td> <td>DB<sub>7</sub></td> <td>~</td> <td>DB<sub>0</sub></td> </tr> <tr> <td>0</td> <td>0</td> <td>1</td> <td>1 0 0 0 0 0 0</td> <td>0</td> </tr> </table>	RS	R/W	DB <sub>7</sub>	~	DB <sub>0</sub>	0	0	1	1 0 0 0 0 0 0	0	<table border="1"> <tr> <td>LCD MODULE DMC16</td> </tr> <tr> <td>_</td> </tr> </table>	LCD MODULE DMC16	_	Sets RAM address so that the cursor is positioned at the head of the 2 <sup>nd</sup> line.
RS	R/W	DB <sub>7</sub>	~	DB <sub>0</sub>											
0	0	1	1 0 0 0 0 0 0	0											
LCD MODULE DMC16															
_															
10	Write data to CG/DD RAM <table border="1"> <tr> <td>RS</td> <td>R/W</td> <td>DB<sub>7</sub></td> <td>~</td> <td>DB<sub>0</sub></td> </tr> <tr> <td>1</td> <td>0</td> <td>0</td> <td>0 1 1 0 0 1 1</td> <td>1</td> </tr> </table>	RS	R/W	DB <sub>7</sub>	~	DB <sub>0</sub>	1	0	0	0 1 1 0 0 1 1	1	<table border="1"> <tr> <td>LCD MODULE DMC16</td> </tr> <tr> <td>1_</td> </tr> </table>	LCD MODULE DMC16	1_	Write "1"
RS	R/W	DB <sub>7</sub>	~	DB <sub>0</sub>											
1	0	0	0 1 1 0 0 1 1	1											
LCD MODULE DMC16															
1_															
11	Write data to CG/DD RAM <table border="1"> <tr> <td>RS</td> <td>R/W</td> <td>DB<sub>7</sub></td> <td>~</td> <td>DB<sub>0</sub></td> </tr> <tr> <td>1</td> <td>0</td> <td>0</td> <td>0 1 1 0 0 1 0</td> <td>0</td> </tr> </table>	RS	R/W	DB <sub>7</sub>	~	DB <sub>0</sub>	1	0	0	0 1 1 0 0 1 0	0	<table border="1"> <tr> <td>LCD MODULE DMC16</td> </tr> <tr> <td>16_</td> </tr> </table>	LCD MODULE DMC16	16_	Writes "6"
RS	R/W	DB <sub>7</sub>	~	DB <sub>0</sub>											
1	0	0	0 1 1 0 0 1 0	0											
LCD MODULE DMC16															
16_															
12	⋮	⋮													
13	Write data to CG/DD RAM address <table border="1"> <tr> <td>RS</td> <td>R/W</td> <td>DB<sub>7</sub></td> <td>~</td> <td>DB<sub>0</sub></td> </tr> <tr> <td>1</td> <td>0</td> <td>0</td> <td>0 1 0 1 0 1 0</td> <td>0</td> </tr> </table>	RS	R/W	DB <sub>7</sub>	~	DB <sub>0</sub>	1	0	0	0 1 0 1 0 1 0	0	<table border="1"> <tr> <td>LCD MODULE DMC16</td> </tr> <tr> <td>16 DIGITS, 2 LINES_</td> </tr> </table>	LCD MODULE DMC16	16 DIGITS, 2 LINES_	Writes "S"
RS	R/W	DB <sub>7</sub>	~	DB <sub>0</sub>											
1	0	0	0 1 0 1 0 1 0	0											
LCD MODULE DMC16															
16 DIGITS, 2 LINES_															
14	Set DD/RAM address <table border="1"> <tr> <td>RS</td> <td>R/W</td> <td>DB<sub>7</sub></td> <td>~</td> <td>DB<sub>0</sub></td> </tr> <tr> <td>0</td> <td>0</td> <td>1</td> <td>0 0 0 0 0 0 0</td> <td>0</td> </tr> </table>	RS	R/W	DB <sub>7</sub>	~	DB <sub>0</sub>	0	0	1	0 0 0 0 0 0 0	0	<table border="1"> <tr> <td>LCD MODULE DMC16</td> </tr> <tr> <td>16 DIGITS, 2 LINES</td> </tr> </table>	LCD MODULE DMC16	16 DIGITS, 2 LINES	Moves cursor to original position
RS	R/W	DB <sub>7</sub>	~	DB <sub>0</sub>											
0	0	1	0 0 0 0 0 0 0	0											
LCD MODULE DMC16															
16 DIGITS, 2 LINES															
15	Clear display <table border="1"> <tr> <td>RS</td> <td>R/W</td> <td>DB<sub>7</sub></td> <td>~</td> <td>DB<sub>0</sub></td> </tr> <tr> <td>0</td> <td>0</td> <td>0</td> <td>0 0 0 0 0 0 0</td> <td>1</td> </tr> </table>	RS	R/W	DB <sub>7</sub>	~	DB <sub>0</sub>	0	0	0	0 0 0 0 0 0 0	1	<table border="1"> <tr> <td>_</td> </tr> <tr> <td> </td> </tr> </table>	_		Return both display and cursor to the original position
RS	R/W	DB <sub>7</sub>	~	DB <sub>0</sub>											
0	0	0	0 0 0 0 0 0 0	1											
_															
16	⋮	⋮													

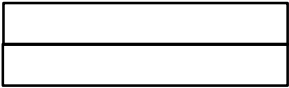
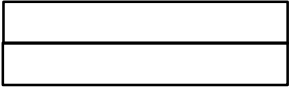
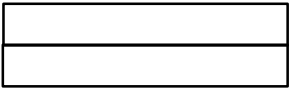

### 3.2.3 16 Character x 2 Line Display (4-bit interface, 1/16 duty)

No.	Instruction	Display	Operation															
1	Power supply ON (Initialized by Internal reset circuit) <table border="1"> <tr> <td>RS</td> <td>R/W</td> <td>DB<sub>7</sub></td> <td>~</td> <td>DB<sub>4</sub></td> </tr> <tr> <td>/</td> <td>/</td> <td></td> <td></td> <td></td> </tr> </table>	RS	R/W	DB <sub>7</sub>	~	DB <sub>4</sub>	/	/					Module is initialized.					
RS	R/W	DB <sub>7</sub>	~	DB <sub>4</sub>														
/	/																	
2	Function set <table border="1"> <tr> <td>RS</td> <td>R/W</td> <td>DB<sub>7</sub></td> <td>~</td> <td>DB<sub>4</sub></td> </tr> <tr> <td>0</td> <td>0</td> <td>0</td> <td>0</td> <td>1 0</td> </tr> </table>	RS	R/W	DB <sub>7</sub>	~	DB <sub>4</sub>	0	0	0	0	1 0		Sets the interface data length to 4 bits. Since the module has been 8 bits by initial set, instruction is required only one time.					
RS	R/W	DB <sub>7</sub>	~	DB <sub>4</sub>														
0	0	0	0	1 0														
3	Function set <table border="1"> <tr> <td>RS</td> <td>R/W</td> <td>DB<sub>7</sub></td> <td>~</td> <td>DB<sub>4</sub></td> </tr> <tr> <td>0</td> <td>0</td> <td>0</td> <td>0</td> <td>1 0</td> </tr> <tr> <td>0</td> <td>0</td> <td>1</td> <td>x</td> <td>x x</td> </tr> </table>	RS	R/W	DB <sub>7</sub>	~	DB <sub>4</sub>	0	0	0	0	1 0	0	0	1	x	x x		Set the interface data length to 4 bits and select 2-line display and 5 x 7-dot character font. Since it is operated as 4 bits from here, re-sending is necessary.
RS	R/W	DB <sub>7</sub>	~	DB <sub>4</sub>														
0	0	0	0	1 0														
0	0	1	x	x x														
4	Display ON/OFF control <table border="1"> <tr> <td>RS</td> <td>R/W</td> <td>DB<sub>7</sub></td> <td>~</td> <td>DB<sub>4</sub></td> </tr> <tr> <td>0</td> <td>0</td> <td>0</td> <td>0</td> <td>0 0</td> </tr> <tr> <td>0</td> <td>0</td> <td>1</td> <td>1</td> <td>1 0</td> </tr> </table>	RS	R/W	DB <sub>7</sub>	~	DB <sub>4</sub>	0	0	0	0	0 0	0	0	1	1	1 0		Turn on display and cursor.
RS	R/W	DB <sub>7</sub>	~	DB <sub>4</sub>														
0	0	0	0	0 0														
0	0	1	1	1 0														
5	Entry mode set <table border="1"> <tr> <td>RS</td> <td>R/W</td> <td>DB<sub>7</sub></td> <td>~</td> <td>DB<sub>4</sub></td> </tr> <tr> <td>0</td> <td>0</td> <td>0</td> <td>0</td> <td>0 0</td> </tr> <tr> <td>0</td> <td>0</td> <td>0</td> <td>1</td> <td>1 0</td> </tr> </table>	RS	R/W	DB <sub>7</sub>	~	DB <sub>4</sub>	0	0	0	0	0 0	0	0	0	1	1 0		Set mode to increment address by one and shift the cursor to the right at the time of write to internal RAM.
RS	R/W	DB <sub>7</sub>	~	DB <sub>4</sub>														
0	0	0	0	0 0														
0	0	0	1	1 0														
6	Write data to CG/DD RAM <table border="1"> <tr> <td>RS</td> <td>R/W</td> <td>DB<sub>7</sub></td> <td>~</td> <td>DB<sub>4</sub></td> </tr> <tr> <td>1</td> <td>1</td> <td>0</td> <td>1</td> <td>0 0</td> </tr> <tr> <td>1</td> <td>0</td> <td>1</td> <td>1</td> <td>0 0</td> </tr> </table>	RS	R/W	DB <sub>7</sub>	~	DB <sub>4</sub>	1	1	0	1	0 0	1	0	1	1	0 0		Writes "L". Cursor is incremented by one and shift to the right.
RS	R/W	DB <sub>7</sub>	~	DB <sub>4</sub>														
1	1	0	1	0 0														
1	0	1	1	0 0														

## 4 Electrical Characteristics

### 4.1 Absolute Maximum Ratings

The absolute maximum ratings of a display module may vary from one to another. Please contact your local Optrex Sales Representative for a detailed module specification.

### 4.2 Timing Characteristics

#### 4.2.1 Write Operation

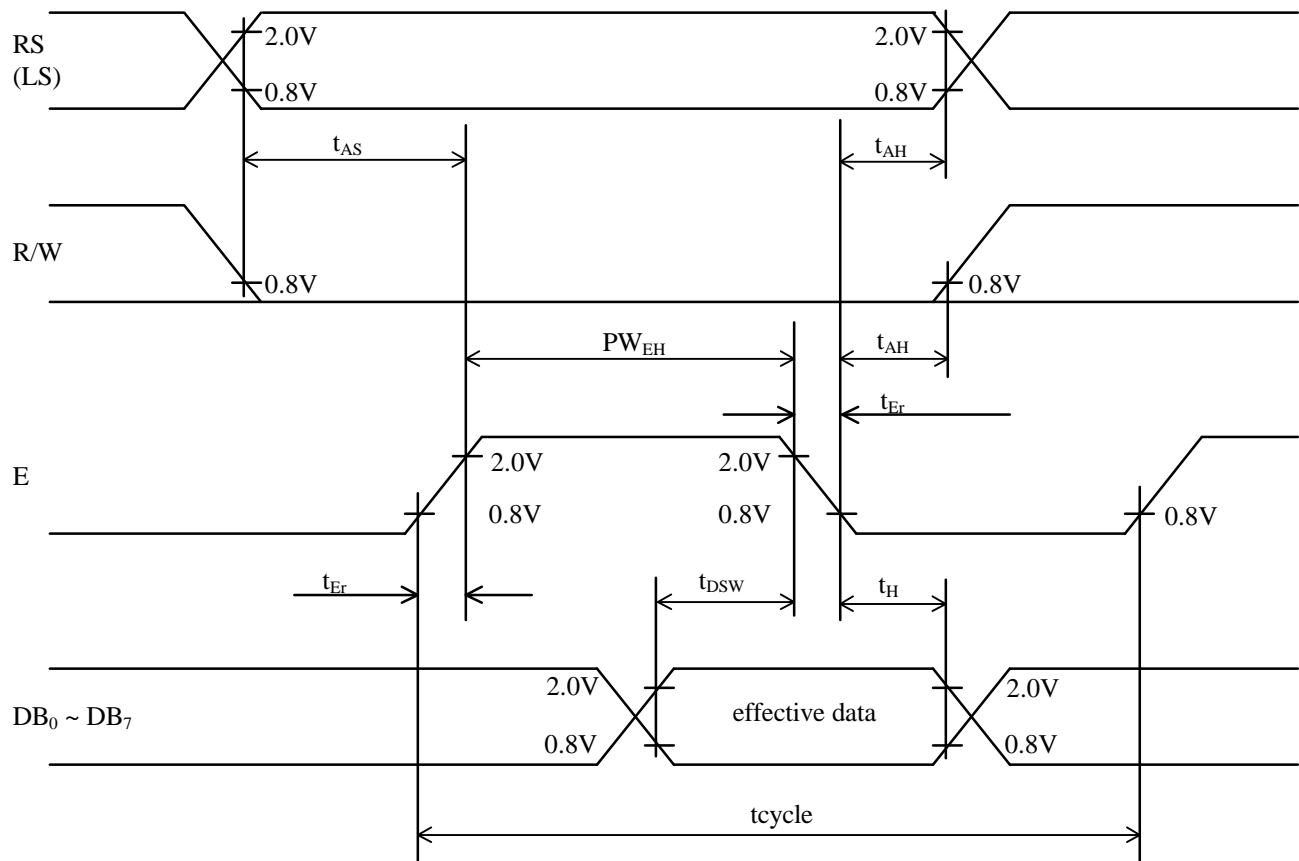

**Fig. 4.1**  
Bus Write Operation Sequence.  
(Writing data from MPU to Module)

### 4.2.2 Read Operation

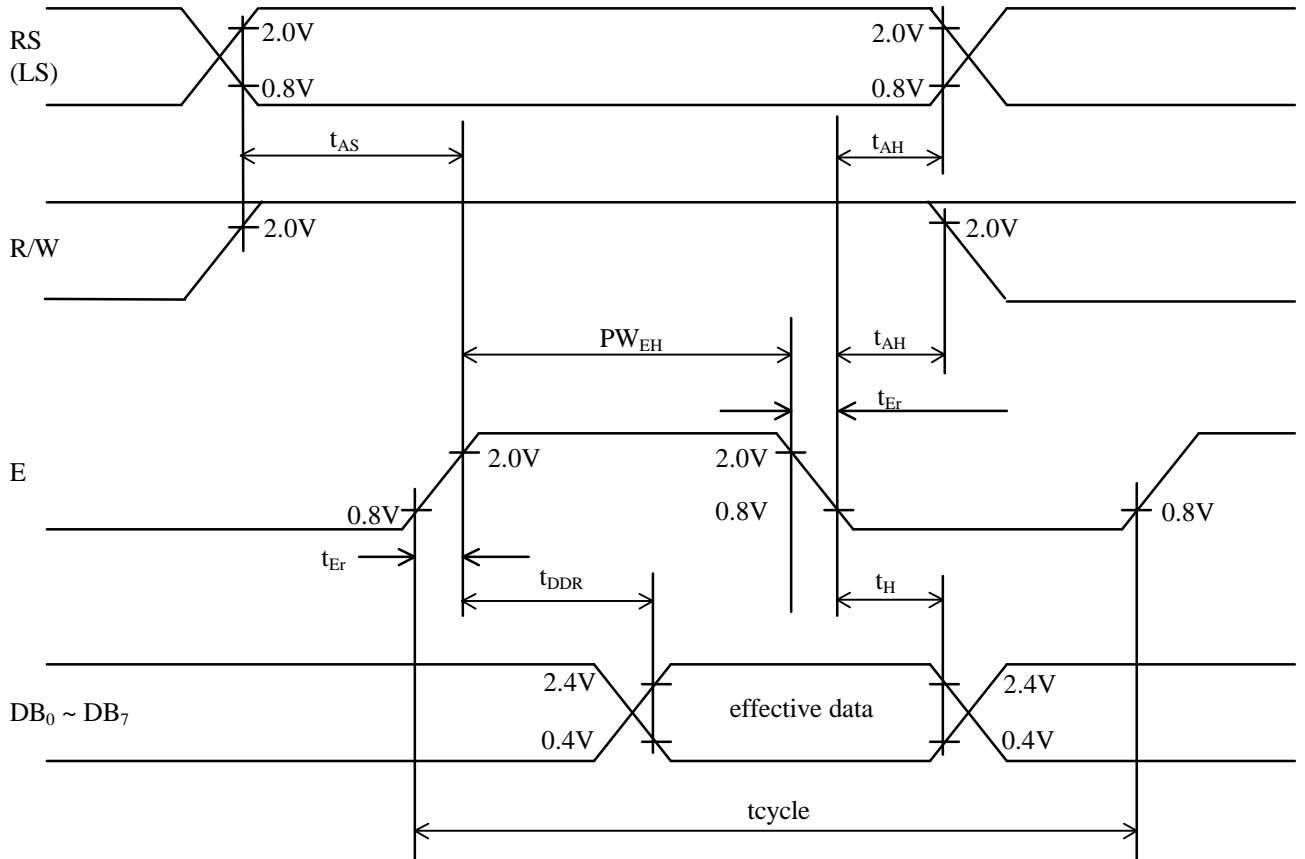

**Fig. 4.2**  
 Bus Read Operation Sequence  
 (Reading data from Module to MPU)

### 4.2.3 Timing Characteristics of Each Drawing

(Vcc = 5.0V ± 5%, Vxx = 0V, Ta = 0 ~ 50-C)

Write timing characteristics (Fig. 4.1)

Item	Symbol	Specs. Value		Unit
		Min.	Max.	
Enable cycle time	tcycle	1000	-	ns
Enable pulse width	“High” level PW <sub>EH</sub>	450	-	ns
Enable rising, falling time	t <sub>Er</sub> , t <sub>Ef</sub>	-	25	ns
Set up time	RS, R/W-E t <sub>AS</sub>	140	-	ns
Address hold time	t <sub>AH</sub>	10	-	ns
Data set up time	t <sub>DSW</sub>	195	-	ns
Data hold time	t <sub>H</sub>	10	-	ns

Read timing characteristics (Fig. 4.2)

Item	Symbol	Specs. Value		Unit
		Min.	Max.	
Enable cycle time	tcycle	1000	-	ns
Enable pulse width	“High” level PW <sub>EH</sub>	450	-	ns
Enable rise, fall time	t <sub>Er</sub> , t <sub>Ef</sub>	-	25	ns
Set up time	RS, R/W-E t <sub>AS</sub>	140	-	ns
Data delay time	t <sub>DDR</sub>	-	1320	ns
Data hold time	t <sub>H</sub>	20	-	ns

Note: These read and write timing characteristics are for reference only. Please contact your local Optrex sales representative to obtain the complete LCD module specification for more details.

## 5 Connection Block Diagrams to MPU

### 5.1 Connection with Z-80

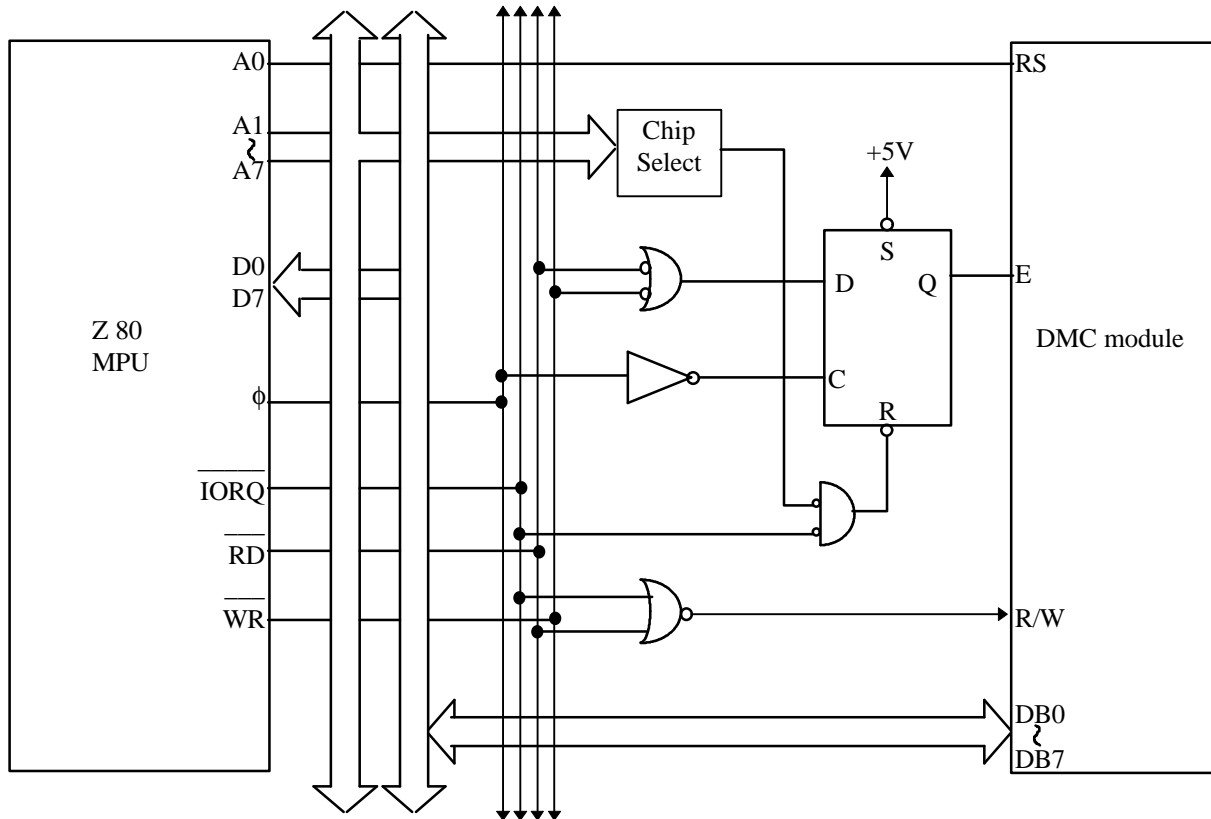

## 5.2 Connection with 8085A

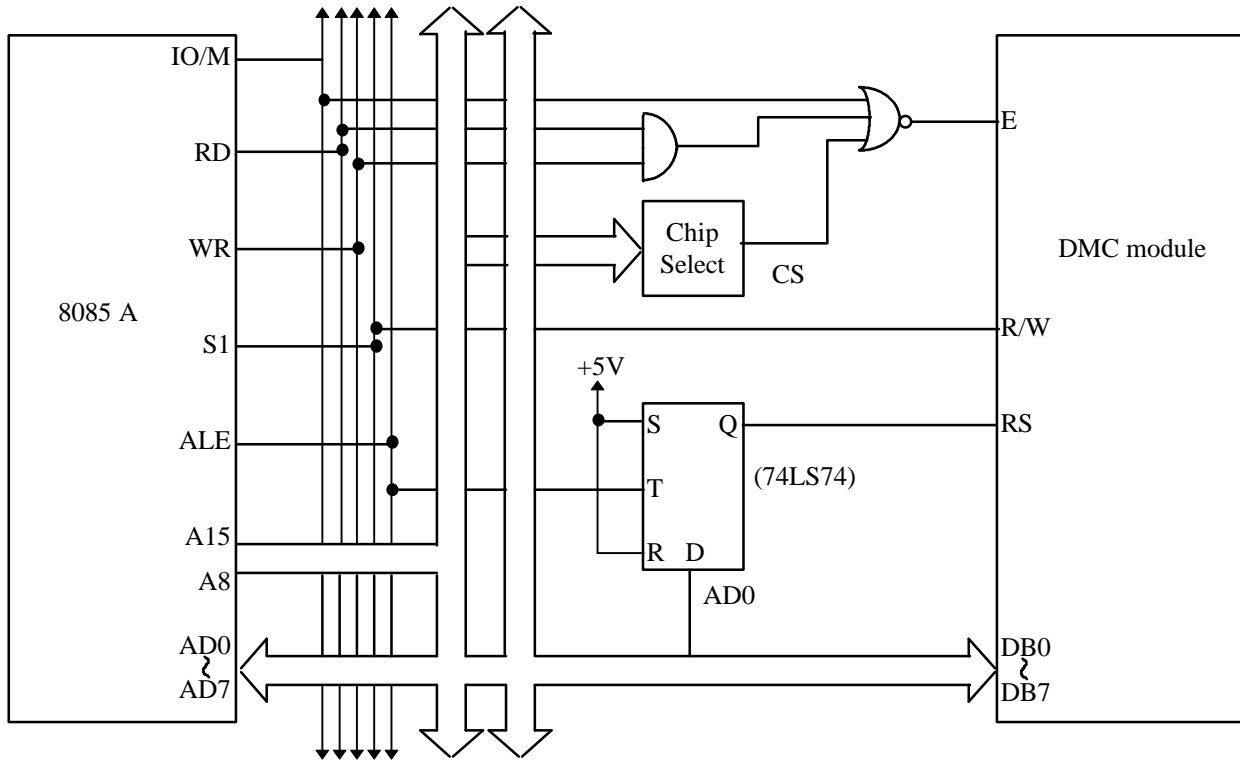

### 5.3 Connection with MC 6800

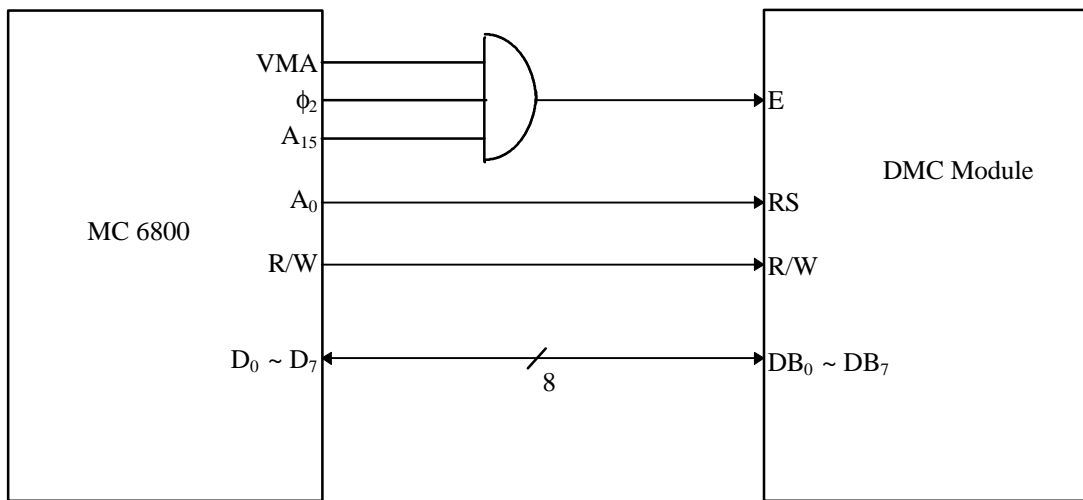
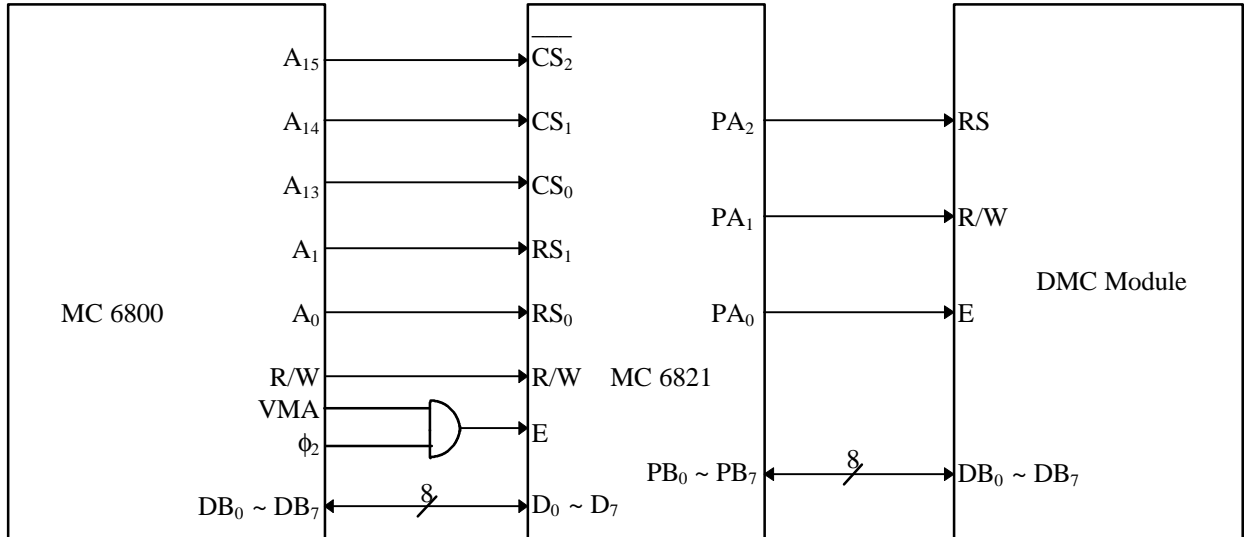

### 5.4 Connection with MC 6809

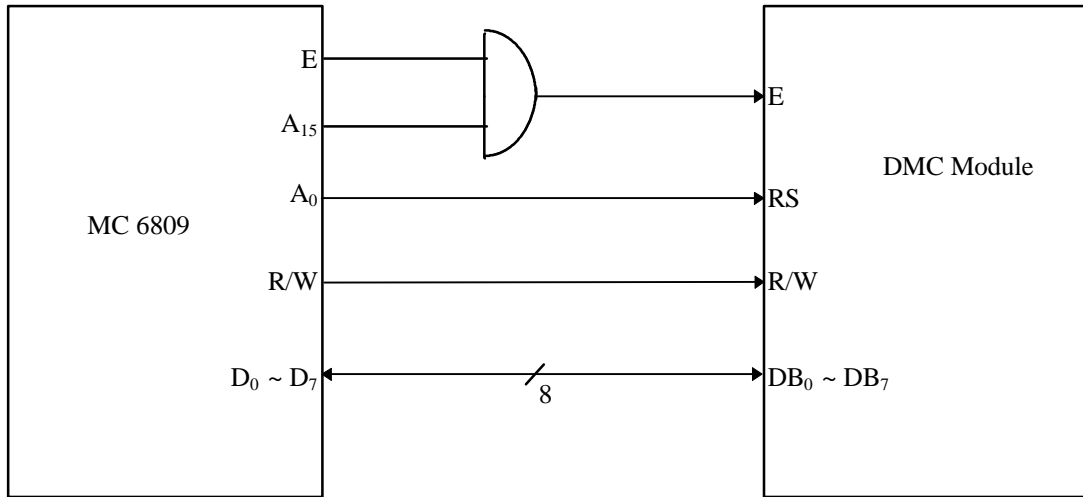

### 5.5 Connection with 80C31 Family (or similar microcontroller) Using I/O Port Interface

4 bit Mode

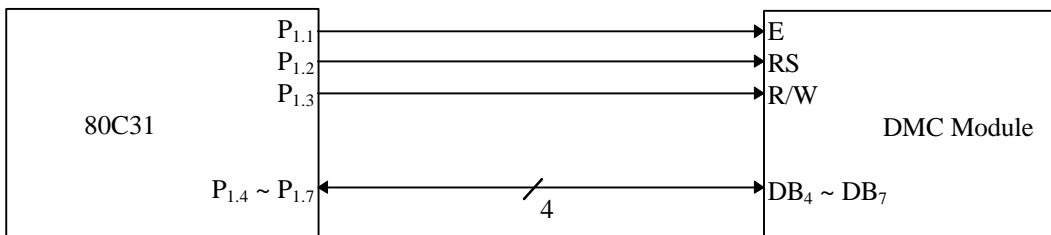

8 bit mode

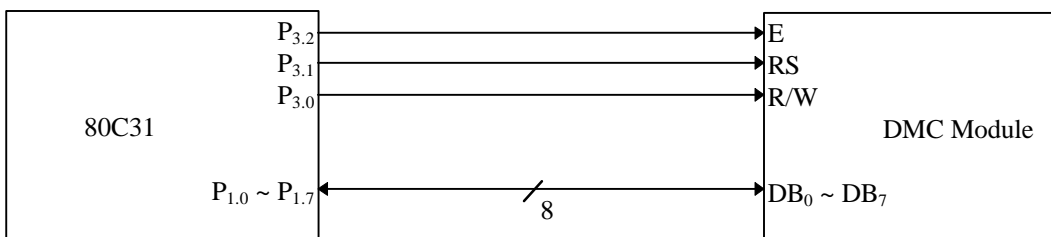



## 6 Special Specifications

### 6.1 EL (back light) Specifications for DMC Series

Note (1) These specifications are for explaining general characteristics of electroluminescence (EL). Detailed data sheets are available from your local Optrex representative for each model. Please contact your local representative for the data.

Note (2) This product has been developed with the cooperation from NEC Corporation.

Characteristics:

- ◆ This is a surface light source using organic film as substrate and packaging material.
- ◆ With the adoption of new materials and production processes, the thickness is reduced to 1.3 mm Max. (Electrode portion is 1.5mm Max.) making it suitable for high density mounting.
- ◆ Color emission is blue-green or white.
- ◆ Driving voltage can be selected from a wide range of 60 ~ 1000 Hz and AC 150V Max.
- ◆ Also with the help of an inverter, voltage increase from a single DC source is easily achieved.
- ◆ Please contact your local Optrex representative for the recommended inverter.

#### 6.1.1 Absolute Maximum Ratings

Operating Voltage	AC 150V RMS
Operating Temperature Range	-10 ~ +50° C
Storage Temperature Range	-30 ~ +60° C

#### 6.1.2 Electrical and Life Characteristics (Color emission: Blue-green)

Please contact your local Optrex representative for detailed specifications of the EL Backlighting.

## 6.2 LED (Backlight) Specifications for DMC Series

LED Backlight characteristics vary from one display module to the next. Please contact your local Optrex representative for detailed specifications.

In general, LED Backlit modules include an array of LED's positioned behind the LCD panel.

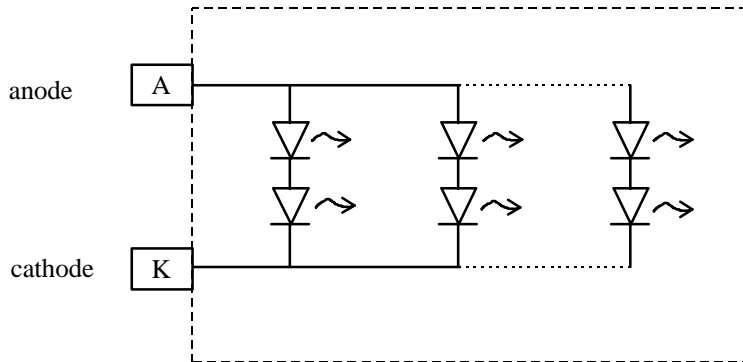

Optrex specifies the absolute maximum current for the LED array in the detailed module specification.

Also specified is the LED Forward Voltage at optimum current level.

Example:  $V_F @ I_{nom}$  [mA]

A current limiting resistor should be added in series to limit the current to the LED assembly. The resistor can be calculated as follows:

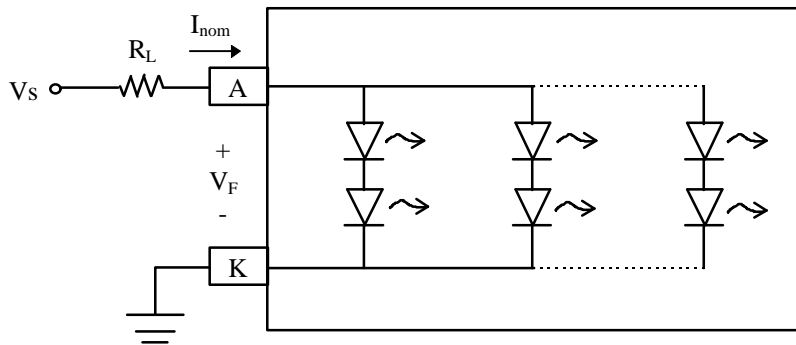

$$R_L = \frac{V_S - V_F}{I_{nom}} \text{ [ohm]}$$

Note:  $I_{nom}$  can be found in the  $V_F$  rating of the LCD module specification.

### **6.3 High Reliability Specifications**

Among the DMC series, some of the modules are made to meet high reliability specs., using liquid crystal suitable for a wide range of temperatures. Those modules have an “H” in their part number to distinguish them from the others.

However, high reliability modules use liquid crystal fluid and power sources of different characteristics. Caution should be taken when putting them to use.

- (1) Operating Temperature     $-20^{\circ}\text{C} \sim +70^{\circ}\text{C}$
- (2) Storage Temperature       $-30^{\circ}\text{C} \sim +80^{\circ}\text{C}$

Note: Even in these “H” modules, the specifications for EL Backlight are standard levels. (See section 6.1)

### **6.4 Examples of Temperature Compensation Circuits (For reference only)**

Liquid Crystal materials are temperature dependent. In other words, the Contrast Ratio of an LCD can vary based on the ambient temperature of the LCD panel. Temperature Compensation circuits can be used to obtain optimum contrast across the temperature range.

Typical contrast voltage vs. temperature curves for Optrex “H” version LCD modules are shown in Fig 6.1 and 6.2

In order to maintain optimum contrast across the temperature range, the LCD module contrast voltage must be held as close as possible to the nominal curve.

Note:     LCD module contrast voltage is measured with respect to  $V_{cc}$  (i.e.  $V_{cc} - V_{ee} = V_o$ )

The circuits in Fig. 6.1 and 6.2 are examples of how this temperature compensation can be achieved.

Note:      $R_{TH}$  should be mounted such that the ambient temperature of  $R_{TH}$  and the LCD panel are as close as possible to each other.

**Fig. 6.1**  
**1/8 Duty - 1/3 Bias**

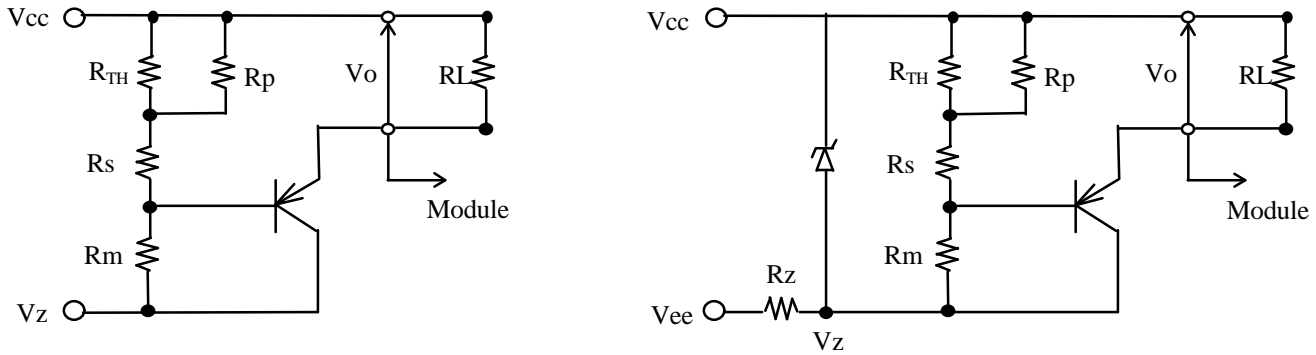

Thermistor :  $R_{TH}(25^\circ C) = 15[k\text{-ohm}]$ ,  $B = 4200[K]$   
 Resistors :  $R_p = 30[k\text{-ohm}]$ ,  $R_s = 6.8[k\text{-ohm}]$ ,  $R_m = 3.3[k\text{-ohm}]$   
 Transistor : PNP Type  
 $V_{cc} : +5[V]$ ,  $V_{ss} : 0V$  (Logic Supply)  
 $V_z : -8[V]$  (-7.8 to -8.2[V])  
 $V_{ee} < V_z[V]$ ,  $R_z = (V_z - V_{ee})/5[k\text{-ohm}]$

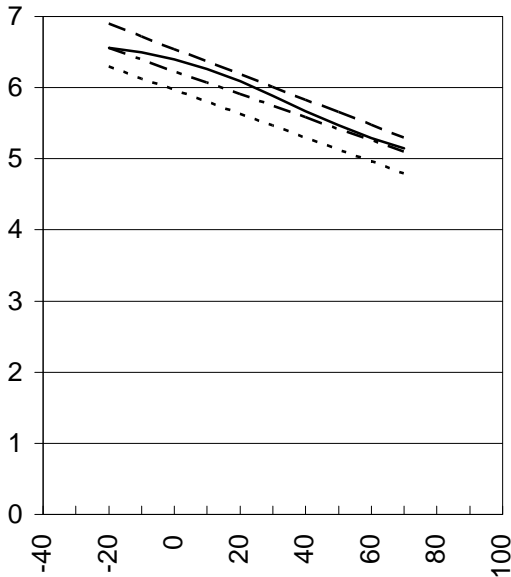

$R_p = 30 [k\text{-ohm}]$       - - - - -  $V_{TH} \text{ OFF}$   
 $R_s = 6.8 [k\text{-ohm}]$       ······  $V_{TH} \text{ Nominal}$   
 $R_m = 3.3 [k\text{-ohm}]$       - · - · -  $V_{TH} \text{ ON}$   
                                      ———  $V_{TH} \text{ Actual}$

Ta[°C]	Vo[V]
-20	6.56
-10	6.50
0	6.40
10	6.26
20	6.09
30	5.88
40	5.67
50	5.47
60	5.29
70	5.15

$R_{TH}(25^\circ C) = 15 [k\text{-ohm}]$   
 $\beta = 4200 [K]$

\* Specifications are subject to change without notice.

**Fig. 6.2**  
**1/16 Duty - 1/5 Bias**

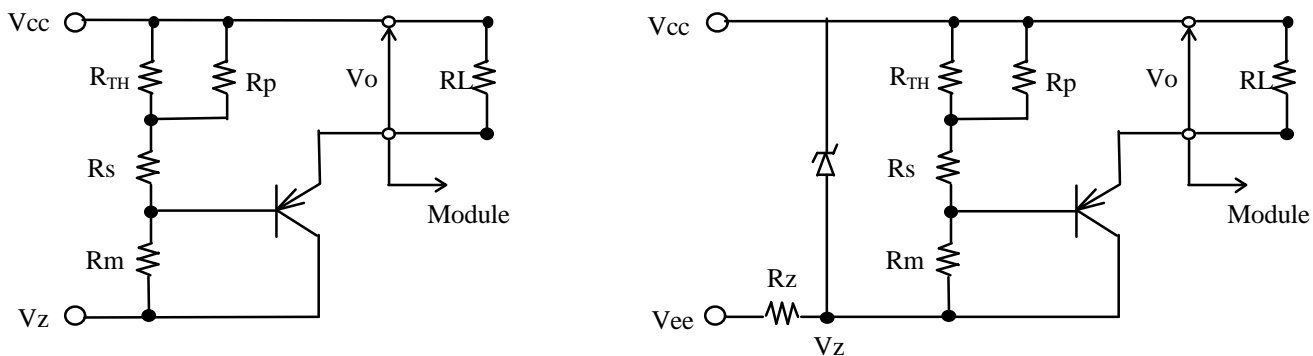

Thermistor :  $R_{TH}(25^\circ\text{C}) = 15[\text{k-ohm}]$ ,  $B = 4200[\text{K}]$   
 Resistors :  $R_p = 510[\text{k-ohm}]$ ,  $R_s = 8.2[\text{k-ohm}]$ ,  $R_m = 3.9[\text{k-ohm}]$   
 Transistor : PNP Type  
 $V_{cc} : +5[\text{V}]$ ,  $V_{ss} : 0\text{V}$  (Logic Supply)  
 $V_z : -11[\text{V}]$  (-10.725 to -11.275[V])  
 $V_{ee} < V_z[\text{V}]$ ,  $R_z = (V_z - V_{ee})/5[\text{k-ohm}]$

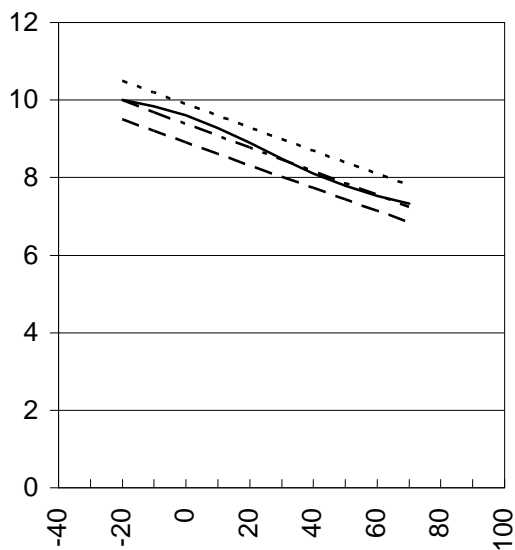

$R_p = 510 [\text{k-ohm}]$       - - - - -  $V_{TH}$  OFF  
 $R_s = 8.2 [\text{k-ohm}]$       ······  $V_{TH}$  Nominal  
 $R_m = 3.9 [\text{k-ohm}]$       - · - · -  $V_{TH}$  ON  
    ————  $V_{TH}$  Actual

Ta[°C]	Vo[V]
-20	10.01
-10	9.84
0	9.60
10	9.28
20	8.89
30	8.49
40	8.11
50	7.79
60	7.53
70	7.33

\* Specifications are subject to change without notice.  $R_{TH}(25^\circ\text{C}) = 15 [\text{k-ohm}]$   
 $\beta = 4200 [\text{K}]$